

Styling

THE LOOK OF THINGS





At dusk—GM Styling Administration Building, Studio Building and Auditorium Dome as viewed from across the main lake at the General Motors Technical Center, Detroit, Michigan.



Inside the lobby of the Styling Administration Building, visitors glimpse the atmosphere of creativity that forms a backdrop for the men who inspire the look of things to come.

In the Interior and Color Studio, a spectrum of 3,900 color plates plus hundreds of rich textiles give the designers great flexibility of selection of colors and textures for automobiles and other products.



A word about the front cover . . .

The unusual front cover design is a color photograph of a sample display rack in GM Styling. Each of the rectangular shapes is a piece of textured metal or plastic which at some time or another has been used or considered for enriching the surface of a GM product. The idea is especially appropriate for a booklet on Styling because it makes use of the Stylist's own materials, arranging them in a manner symbolic of such fundamental Styling principles as variety, rhythm and symmetry.

Styling

THE LOOK OF THINGS

Produced with the cooperation
and technical assistance of the
GENERAL MOTORS STYLING STAFF

by the

Public Relations Staff
GENERAL MOTORS
Detroit 2, Michigan

always in the FUTURE

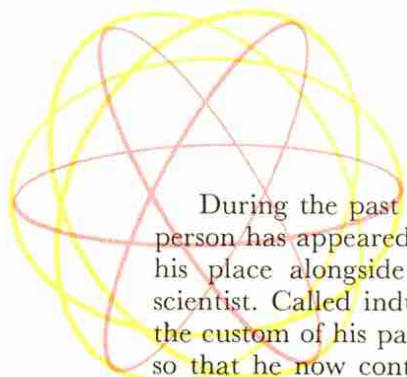

During the past twenty-five years, a new kind of creative person has appeared on the American industrial scene taking his place alongside the engineer, production expert, and scientist. Called industrial designer, or Stylist, depending on the custom of his particular business, his influence has grown so that he now controls the appearance of practically every product and convenience we use.

His is the task of making these useful things beautiful, not in the sense of applying superficial surface ornamentation, but in developing a form of beauty exactly suited to the purpose—a form of beauty evolved from within.

Because of the growing importance of styling, both as a profession and as a factor in our everyday lives, many people have indicated an interest in knowing more about this fascinating subject. Few ever have the opportunity to see the inside of a professional design studio, since secrecy is a necessary part of the process. Undoubtedly, this is also one of the reasons why there is little printed material available on this glamorous activity. Talented young people who aspire to train for this profession often do not know where to begin.

It was with these thoughts in mind that this booklet has been prepared. On the following pages you'll see how the Stylist has transformed many familiar prosaic objects into things of utility *and* beauty.

You'll gain a new understanding of the bricks and mortar of design: how design elements such as line, plane, form and surface quality are blended together to create visual beauty.

Then follows a story of styling the American automobile. Considerable space is devoted to this phase of styling, because the automobile is the most important product in number and value designed by the styling profession.

You'll learn why the automobile looked as it did at various stages of development, from the year 1895 to the present time. You'll visit a modern automobile design studio, photographically, of course, for a candid day-by-day report on the development of a beautiful dream car.

By the time you reach the final pages we hope you'll understand why the Stylist is never content with what *is* or what *has been*—why he lives always in the future—dealing with what *will be*.

In this he differs from those who are sometimes content with traditional forms of beauty. He's a pioneer in aesthetics, for which we may be thankful, since out of his restless, inquisitive searching are born new standards of beauty and usefulness that will further enrich the lives of everyone.

HARLEY J. EARL

VICE-PRESIDENT OF GENERAL MOTORS CORPORATION
IN CHARGE OF STYLING STAFF

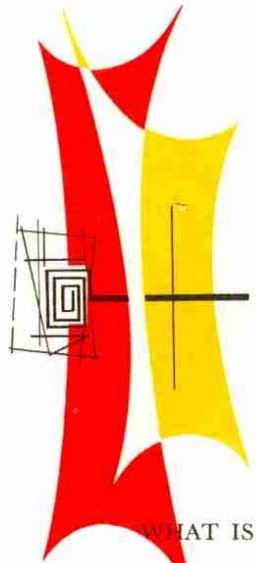
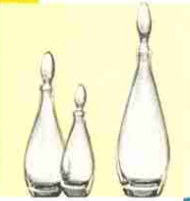
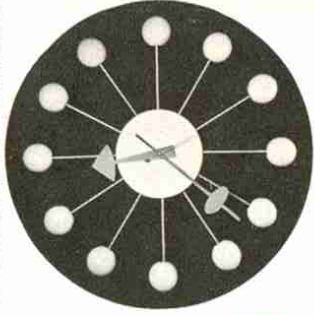

table of contents

	Page		Page
WHAT IS A STYLIST?	4	Compare your Design Taste with the Experts'	24
<p>A story of how the Stylist came to be! Representative examples of his work are shown and his three-fold objectives are outlined. The importance and significance of styling as a factor in mass production and distribution is noted.</p>		<p>Featuring a series of drawings by students of Pratt Institute which illustrate good and bad applications of basic design principles.</p>	
THE FUNDAMENTALS OF DESIGN	14	EVOLUTION OF DESIGN IN THE AMERICAN AUTOMOBILE	26
<p>A short introduction to the language and principles used by the Stylist. Of special interest to students of industrial design.</p>		<p>The story, from the Stylist's viewpoint, of the American automobile and its evolution through 12 major styling phases. Why cars of each period looked as they did is analyzed and explained.</p>	
The Elements of Design	15	MODERN AUTOMOBILE STYLISTS DESIGN A DREAM CAR	48
<p>A discussion of line, plane, form and surface quality (including value, color and texture), which is helpful in clarifying and tying down some specifics about visual organization.</p>		<p>A photo report on the actual design and fabrication of a modern dream car beginning with an idea and ending with a beautiful Fiberglas prototype.</p>	
The Principles of Design	21	THREE CASE HISTORIES	66
<p>Though not an exact science, good design is characterized by recognizable qualities such as unity, balance, proportion and rhythm.</p>		<p>A brief analysis of the fundamental approach behind the design of the lightweight Aerotraine, the front-wheel drive L'Universelle Truck and the Kitchen of Tomorrow.</p>	





What is a Stylist

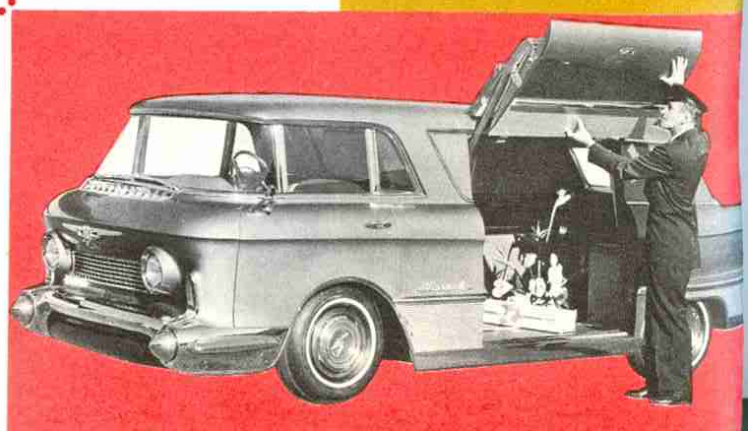
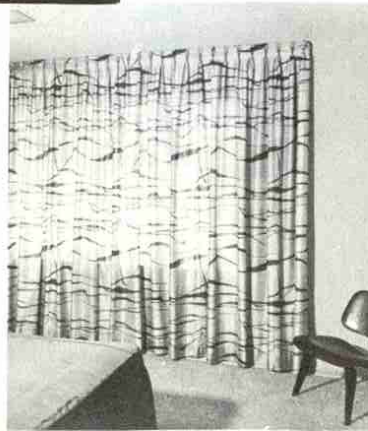
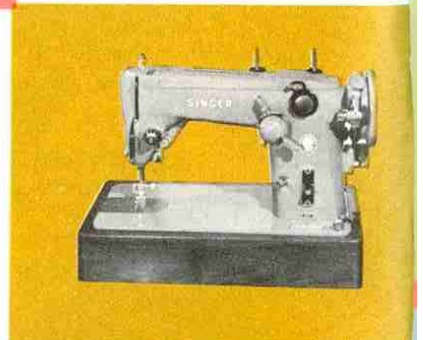
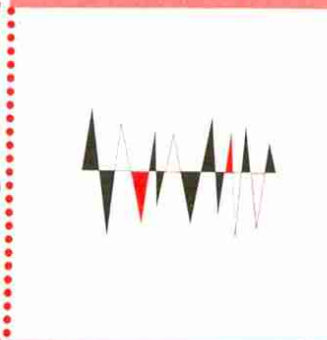
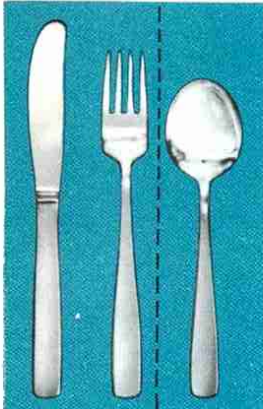
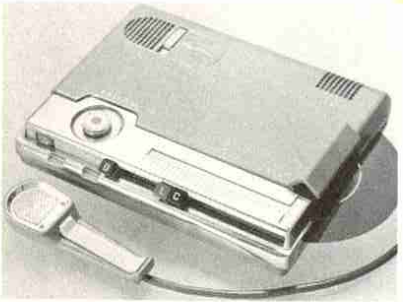

Beauty, an Emotional Experience

Deep within everyone of us lies an appreciation for visual beauty. We seek beauty and orderliness. We avoid ugliness and disorder whenever possible. Our enjoyment of beauty is instinctive, based on an emotional response that authorities call aesthetic appreciation.

This emotion is not a superficial feeling to be derided or ignored, but a worthwhile experience that all of us share, although we often disagree on individual examples of beauty. The presence of beauty, it should be recognized, is a biological necessity, important to the happiness and welfare of all mankind. As this idea receives the increased attention it deserves, we will be able to plan a new, more satisfying way of living in better organized, more beautiful surroundings. It will provide us with utensils, tools, furniture, homes, schools, factories and cities that are more beautiful and efficient.

Creativity, the Ability to Materialize Beauty

An appreciation for beauty is not the exclusive gift of any one group of people nor of any civilization. It has been given to all peoples. Even primitive man revered the beauties of nature and in his crude way attempted to create beauty himself. He decorated his weapons and made paintings on the walls of caves.

Although every generation has the capacity to respond to beauty, it is given to only a few individuals in each lifetime to create beauty. To visualize in his own mind lines and shapes and color combinations that are beautiful is the ability usually associated with the artist, and more recently with the Stylist. Either is able to express his ideas and feelings in such

DESIGNERS AND MARKETERS OF PRODUCTS ON OPPOSITE PAGE: Buick Wildcat III by GM Styling; Edison Voicewriter by Carl Otto; Greyhound Scenicruiser by GM Styling and GMC Truck and Coach Division; Refrigerator, Frigidaire Kitchen of Tomorrow by GM Styling; Swedish crystal decanters for Bonniers; Clock by George Nelson for Howard Miller Clock Co.; Stainless steelware by Folke Arströme for Bonniers; Lamp by George Nelson for Howard Miller Clock Co.; Lounge chair by Eero Saarinen for Knoll Associates, Inc.; Drapery by Ruth Adler for Adler-Schnee Associates; Lightweight Aerotractor by GM Styling for Electro-Motive Division; Euclid tractor by GM Styling; Singer Sewing Machine; L'Universelle truck by GM Styling for GMC Truck and Coach Division.

a way as to invite response. Thus art and styling are forms of communication between the mind and emotions of the creator and the minds and emotions of the viewers.

Art and the Artist

Art is a subject about which most of us know very little. We associate art with galleries full of paintings or with "long-haired" theorists. We neither understand the goals of the artist nor the techniques he uses.

To the individual creative artist his work is a personal, precious thing and he sometimes forgets that other people don't share his viewpoint, and as a result he is faced with a problem of timing. His artistry, even though excellent, may be too far ahead of its time for public appreciation.

The work of the artist lies in the field of the fine arts, which include painting, sculpture, architecture, music, and poetry. In the fine arts, self-expression is the dominant force. Through the use of artistic symbols the artist attempts to express his ideas, feelings and attitudes. In music the symbols are vibrating tones which can be combined in infinite variety and according to countless rhythms. In painting and sculpture the symbols are lines, shapes and colors, balanced and proportioned in rhythmic fashion according to the personality of the individual artist.

Although the artist attempts to communicate with the viewer, it is usually without regard to the viewer's likes or dislikes. Then, too, the fine arts, with the exception of architecture, have little practical connection with utility in our

The Three Musicians, by Pablo Picasso, from the Museum of Modern Art, New York, an example of a little understood technique in modern painting known as cubism. Several partial views of the figures are shown as an artistic arrangement without regard to the normal visual order. Cubism attempts to record a three-dimensional impression on a two-dimensional plane.



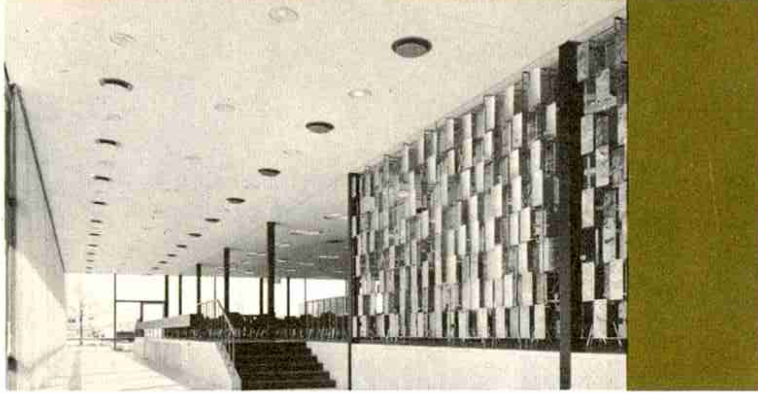

Metal sculpture by Harry Bertoia at General Motors Technical Center is made of rods and pieces of braised sheet metal, the proportions of which are related to the overall. In addition to aesthetic appeal, the screen has practical qualities as an interior arbor, at once separating and joining the space on either side.

everyday lives. These are the important distinctions between the artist and the Stylist, who can never forget the personal taste of the viewers or the utility of his design.

The Craftsman, Predecessor of the Stylist

It was in the handiwork of the craftsmen and artisans that the principles of beauty first came to be applied to practical, everyday things. In pottery, textiles, armor and furniture of the past, we find some of the best examples of artistic expression in the history of mankind.



Hand craftsmanship in glassware, porcelain and pottery. (Above) Blown three-mold glass sugar bowl, New England, 1820-35. (Middle) Porcelain teapot, Meissen, about 1750. (Bottom) Chinese vase, Proto-Porcelain, III Century A.D. with olive glaze and incised decoration. From the Detroit Institute of Arts.



Fragment of a garment, Peruvian, A.D. 900-1000. Its embroidered pattern shows that this primitive people understood the importance of such principles as variety and rhythm in design. From the Detroit Institute of Arts.

Beauty and utility in arms and armor. (Right) Full suit of Gothic armor, 1480. Graceful lines and elegance of form are combined in a design that also reflects a complete understanding of human anatomy and body movements. Although weighing only 35 pounds, its surface could withstand heavy impacts. (Below) Cup-hilted rapier and dagger for the left hand. From the Detroit Institute of Arts.

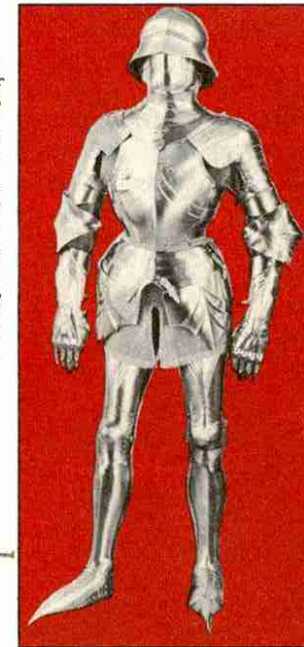

Woman's dress of brocaded taffeta, French, 3rd quarter 18th Century. From the Detroit Institute of Arts.



Silver teapot by Paul Revere, 1735-1818, outstanding example of craftsmanship in metal by an American almost as well known for his skill as a silversmith as for his patriotism. From the Detroit Institute of Arts.



the material, purpose and method of manufacture. This called for a man with an artistic background plus a great interest in such aspects as utility, practicality and cost.

A Lesson in Design

Unable to find a man with these combined talents, certain manufacturers here and abroad turned to existing art forms as a source of beauty. By copying popular decorations and ornaments and applying them as overlays to the product, it was hoped to carry over some of the traditional aesthetic appeal that was associated with the original piece of art.

Design Takes a Back Seat to Productivity

With the invention of power driven machinery, the artisan gradually disappeared and a new kind of producer took charge.

He was variously the production expert, the skilled engineer, the trained metallurgist. These machine age specialists set out to conquer the machine and make it productive of useful commodities. For a time, all design centered around production machinery and the utility of the product it turned out. Aesthetic appearance of the product was entirely forgotten.

In a relatively few years, it came to be realized that machine-made products, though useful, efficient and economical, were anything but beautiful (see page 33). What was needed was a combination artist-designer, someone who could design a special kind of beauty into the product, suitable to

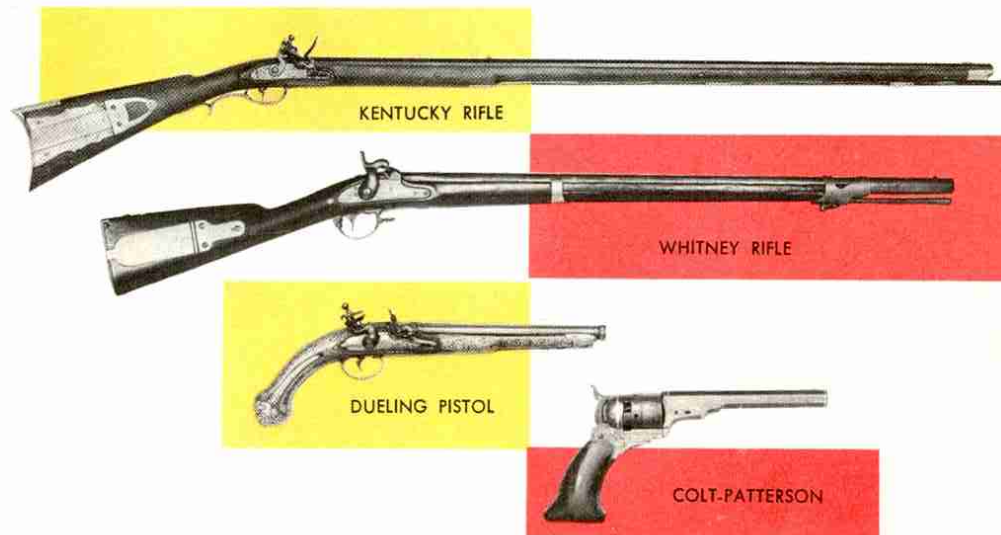

KENTUCKY RIFLE

WHITNEY RIFLE

DUELING PISTOL

COLT-PATTERSON

Authentic Kentucky rifle and ornate silver dueling pistol, both handmade by true craftsmen, are a contrast to the Whitney rifle and Colt-Patterson revolver, both of which were designed for mass production. Appearance of the latter was secondary to such factors as tolerance, interchangeability and price. Guns from collection of Andy Palmer of Detroit.

Examples of the carriage makers' art. Jump seat barouche for four passengers, 1860-1880. Landaulet with convertible top, 1760-1910. Lightweight, graceful lines and large-diameter wheels were typical.

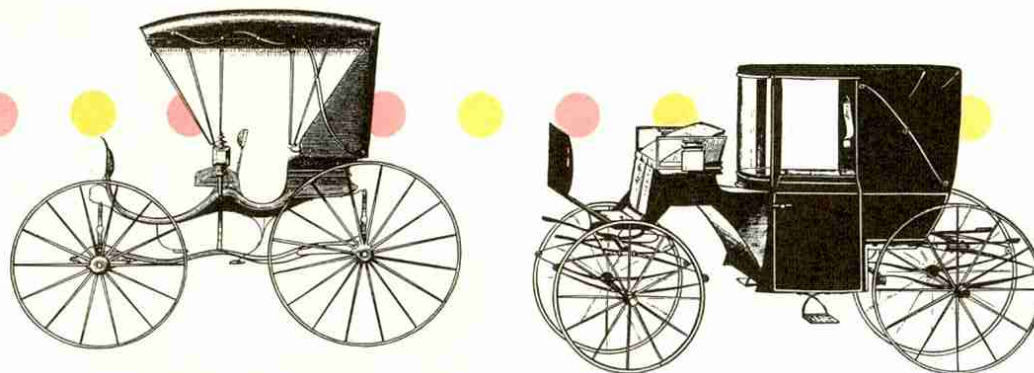

Applying art in this manner is an odd practice when you stop to think about it, and one deplored by today's Stylists. It's not surprising that this custom was never successful, although it has recurred periodically throughout the history of art and design.

The leaves and flowers that look so natural carved in wood, lose their appeal when cast in iron. Statuesque Greek pillars, forms first cut in stone, certainly look out of place on a steam engine.

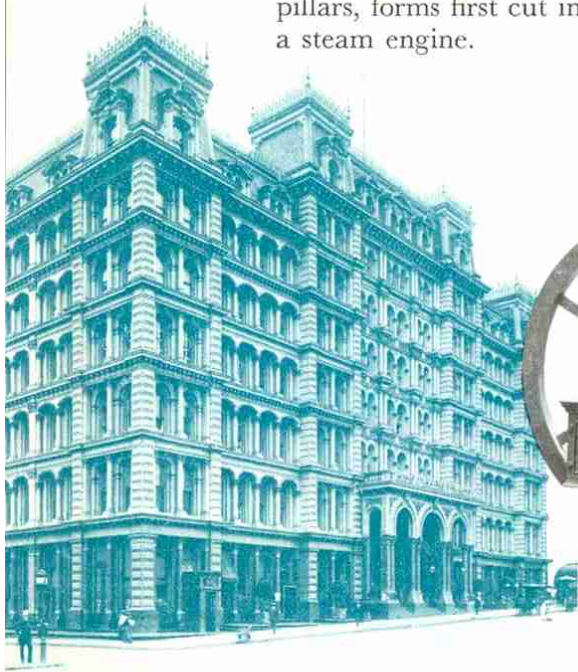

(Above) Park Avenue Hotel, New York. Constructed of cast iron poured in molds to simulate masonry. Photo by Brown Brothers, New York.

(Above right) English steam engine, 1830. Note the incongruity of the steel Corinthian columns, forms originally developed in stone, with the purely functional parts of the engine. British Crown Copyright. From an exhibit in the Science Museum, London.

(Right) Self-feeding base burner for coal or wood, classic example of the heat source that once graced every parlor in America. Its cast iron surfaces were covered with decorations similar to wood carved motifs. Made by Detroit-Michigan Stove Works in 1903.

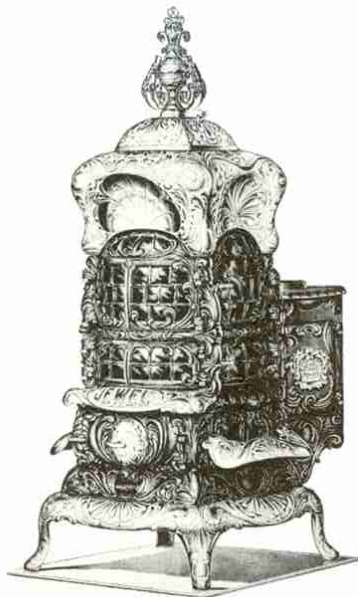
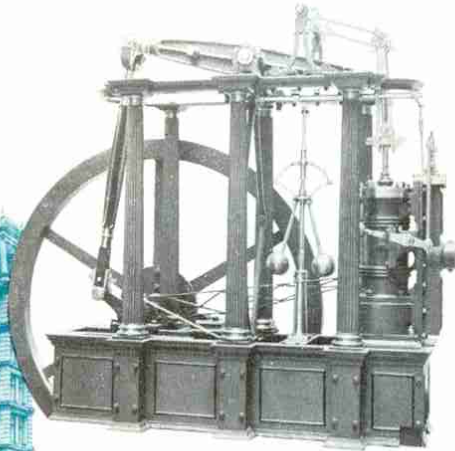

LeSabre, famous experimental automobile introduced in 1950 after four years of development. LeSabre loaned many of its advanced design features to modern production cars.

The Stylist Supplies an Answer

The task of developing a new concept of appearance in keeping with the nature of modern methods and materials has come to rest in the capable hands of the modern Stylist, or industrial designer as he is sometimes called. More and more of the conveniences that contribute to our man-made environment receive his specialized attention: textiles, flatware, tableware, glassware, furniture, appliances, fountain pens, toiletries, buses, trains and automobiles, to name a few.

As with the artist, the Stylist is primarily interested in the Look of Things. Essentially he is an artist, with the gifted ability to create lines, shapes, and color combinations that have emotional appeal. Like the artist, the Stylist aims for new concepts of appearance.

In his vision are thrilling ideas about the future and his

Examples of contemporary industrial design from left to right: Micro-Twin Reader-Recorder by Peter Muller-Munk, manufactured by Bell and Howell and distributed by Burroughs Corp.; Interior and staircase by Eero Saarinen and Associates for General Motors Technical Center; Lavatory by Henry Dreyfuss for Crane Co.; Guardian "70" Duplex Scale by J. M. Little and Associates for Toledo Scale Co.



designs reflect this. He believes that any design, no matter how right today, may need revision tomorrow.

As an aid in fulfilling this ambition, the Stylist is always on the alert for new scientific developments which are related to his particular design problem. As a result he works closely with production, engineering, and scientific experts, and is quick to incorporate their ideas and principles into his design.

For practical reasons he must have his fingers on the public pulse. He must be able to gauge their likes and dislikes accurately in advance so that he can produce a design that will sell.

Because the Stylist is an integral part of a manufacturing process, he must conform to the many restrictions that this process imposes upon him. One of these is the cost of producing the product. Sometimes he is able to reduce costs by simplification or by introduction of a new method. He knows that large expenditures for design can be justified only by popularity of the product.

All Stylists, whether designing for mass production or for small lots, must take three factors into account when developing a useful object. The first of these is function. The Stylist must be so familiar with the use of the product that he adds to rather than detracts from its utility. The second is material. He should choose and use his materials in such a way as to take advantage of their singular characteristics. The third is technique. His design should be well adapted to the manufacturing process.

In the following paragraphs the effect of these three factors on aesthetic appearance is outlined briefly. Although

the influence of function, material, and technique is revealed with the greatest clarity in such simple things as a table, vase, or spoon they also apply in principle to complicated structures.

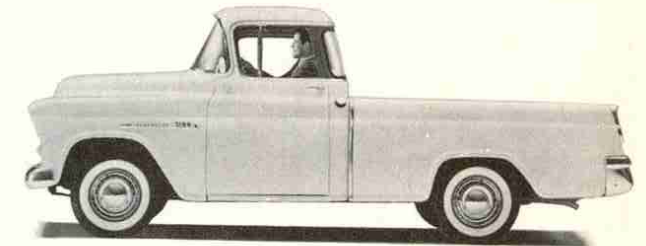
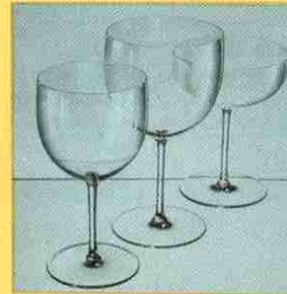
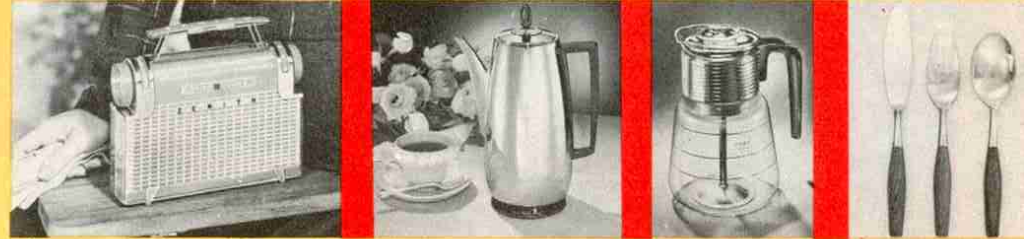

(Clockwise from the left) Brummel crystal water goblet by Baccarat and Porthault, Inc.; Table radio by Robert Davol Budlong for Zenith Radio Corp.; Automatic coffee maker by Mel Boldt and Associates for National Presto Industries, Inc.; Glass percolator by Robert Davol Budlong with Cory Corp. Engineers; Fjord stainless steelware by Jens H. Quistgaard for Bonniers; and Chevrolet Cameo Carrier by GM Styling, first truck to feature flush side construction and automobile styling.

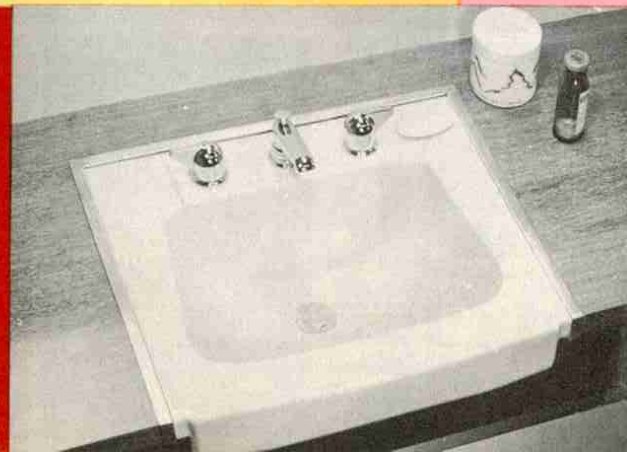

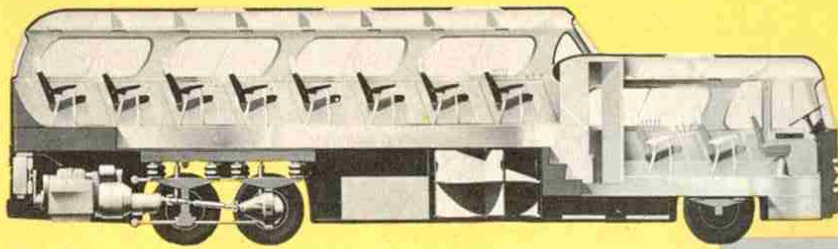

The new proportions and pleasing lines of the GMC Scenicruiser were the result of two basic requirements: one, the need for additional engine and luggage space in a long distance bus; and two, increased passenger comfort and visibility. Both were obtained by elevating the passenger compartment.



Building, interior and furnishings by Eero Saarinen and Associates for General Motors Technical Center.

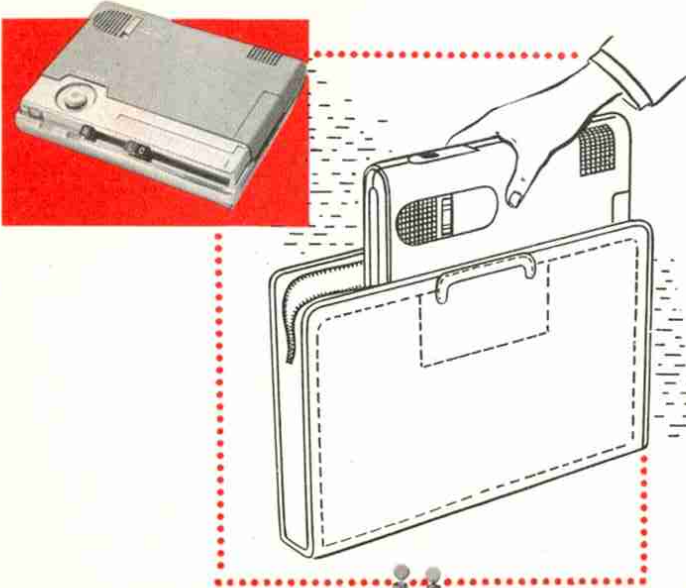

The unusual shape and small size of the Edison Voicewriter permit insertion into a briefcase, making it more useful to men on the move.

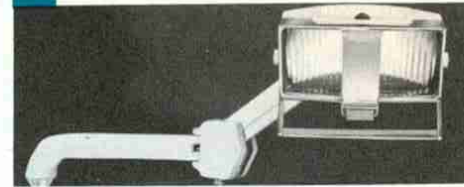

Dental light by Sundberg-Ferar for the Pelton and Crane Co. Requirements: rectangular beam of light, 3" x 8" at 30"; a cool light that is corrected for color; and ease of maneuverability.



The Rochester, a man's watch by Elgin National Watch Co., features a new textured face consisting of a series of concentric circles. The preliminary sketches show a few of the many variations that were considered before arriving at the approved design.

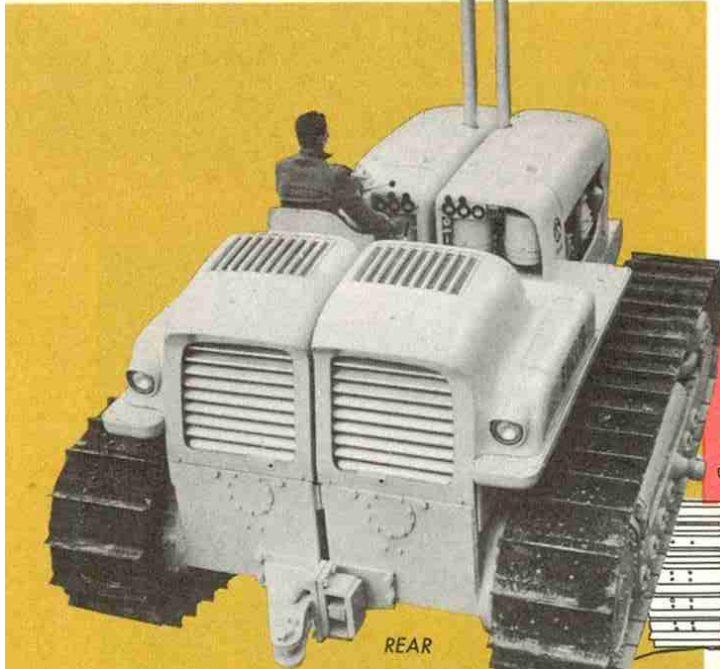

A departure from conventional tractors, this Euclid twin unit has independent track drives, joined by a shaft which permits relative motion and improves traction and maneuverability. Relocation of the radiators in the rear offers protection against dirt and the new front offers better visibility for the driver.

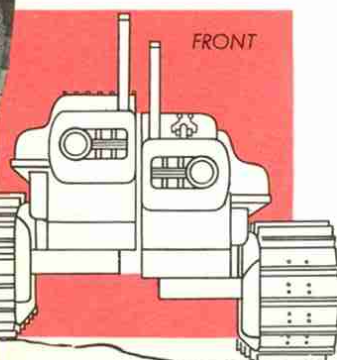

Modern textiles (left to right): Two brocades, fabrics shot with metallic yarn, designed by Alexander Girard for Herman Miller Furniture Co.; and Wireworks, a printed textile by Ruth Adler for Adler-Schnee Associates.

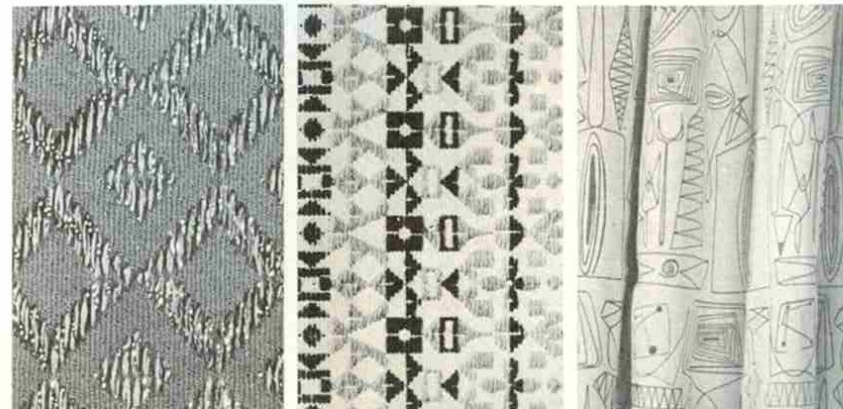

How Function Molds Appearance



In any useful product, the nature of its use has an important effect on appearance. Anything intended for high-speed movement over the ground generally has wheels, and wheels have to be round. Anything that flies through the air must obey aerodynamic laws, which accounts for the airfoil shape of body and wings on planes. Quite often scientific principles are involved, the result of engineering and research studies.

Realizing this, the Stylist studies the function of the object with an inquiring mind. He strives for an appearance that is specially suited for the use, and one that does not violate the practical and scientific aspects of the problem. He tries to mold his design so that it tells what it is intended to do.

He knows from his studies of morphology (the form and structure of animals), that in nature all life looks the way it does because of the forces at work on it. The rate and direction of growth of the life cells is increased at one point, inhibited at another, according to the specific need. And so it is that we can deduce the forces that are acting or have acted on a living thing simply by looking at it.

Realizing that function is equally dependent on the biological and psychological needs of the person who uses the object, the Stylist is an expert in human mechanics; he is familiar with the needs and dimensions of the human body. He knows that human reactions will measure the success of his design. How do people use their hands? What kind of surfaces do they like to touch? What kind of support is required for comfortable use of the legs? To be successful, the design should be pleasant to use and should invite use.

Although everyone agrees that a good design must be functional as well as beautiful, thinking in terms of usefulness alone can be carried too far. If applied strictly to architecture, for example, pure functionalism could produce a monotonous array of cement and glass boxes, in which warmth and originality are completely absent. Most designers also agree that just because an object is functionally correct doesn't necessarily mean that it is also beautiful.



Eero Saarinen, famed architect and designer of this chair, has this to say about function in lounge chairs: "To be comfortable a chair must permit a number of changes in position; it should provide several planes of support and include a head rest; it should achieve a psychological comfort; and its appearance should be a flattering background for the person who sits in it."

Oscar, the dummy pictured here, has the exact dimensions of the average American male. He was developed at General Motors as part of an investigation into the comfort requirements of a human while riding in a moving vehicle. How Oscar limits the design of automobiles is told on page 53

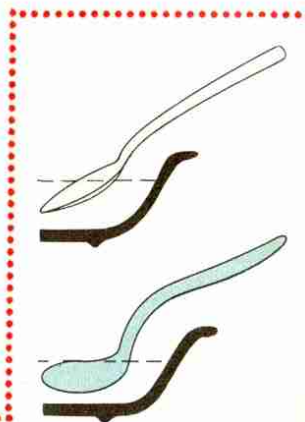
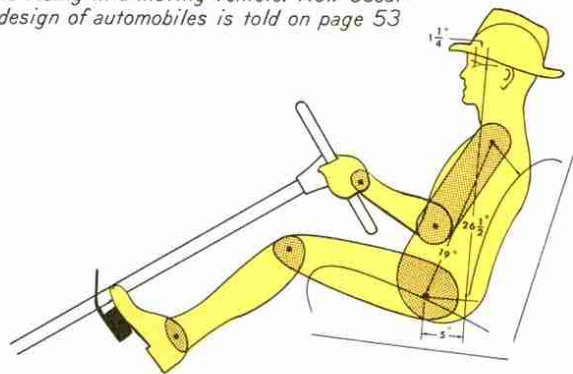

Gio Ponti, an Italian architect and designer, has approached the design of a knife, fork and spoon from a purely functional viewpoint. Discarding convention he has tried to develop more useful tools and to make the three pieces proportional. His new knife has a shortened blade and a cutting edge at a different angle. The fork has short tines and a hollow cavity for scooping up juices and gravies. The spoon has been reshaped to permit better ladling near corners of bowls.

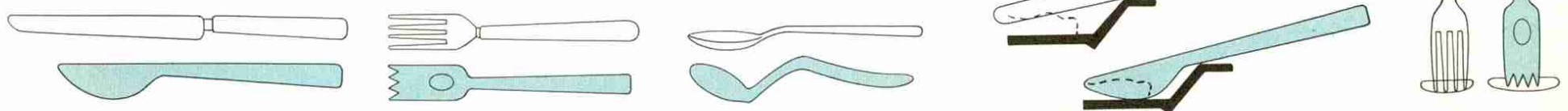

How Materials Both Limit and Enhance Appearance

The materials of which the object is made can also influence its appearance, particularly in basic things which have uncomplicated structures.

Think of a design problem involving the same product but two different materials. Both designs should reflect the designer's understanding of each material and its special properties. The physical result would be entirely different in each case since no two materials should be treated or formed in exactly the same manner.

One material may have inherent surface qualities that are attractive. The grain of certain woods and the satin finish of aluminum and stainless steel are examples. In another material, the method of forming or joining may allow greater flexibility of form. Plastics and metals are more easily formed into curved shapes than wood, for example.

Durability of the material for the proposed service also affects appearance. This includes surface characteristics as well as structural strength. The use of plastic might satisfy the surface finish problem, but would require a bulkier design than wood or metal to produce the same strength characteristics.

The Stylist is fully aware of the importance of materials as design elements and makes it his business to learn a great deal about their special properties. Metals, plastics, textiles, glass, laminated materials and ceramics all have inherent characteristics which on one hand limit their use and on the other stimulate the designer, suggesting new forms and new concepts that are possible only because of the nature of these materials.

That is why the discovery of a new material often suggests to the Stylist a new concept of appearance.

Suitcases made of leather have a characteristic appearance that is a direct result of the nature of leather and the method of working it. Leather is rather inflexible and can be formed only to a limited extent. With the innovation of low-pressure molded plastics, a new form logically was developed. American Tourister Luggage by Jon W. Hauser.



High-tensile steel in combination with reinforced concrete make possible the light airy appearance of this entrance way to a GM Technical Center Building.

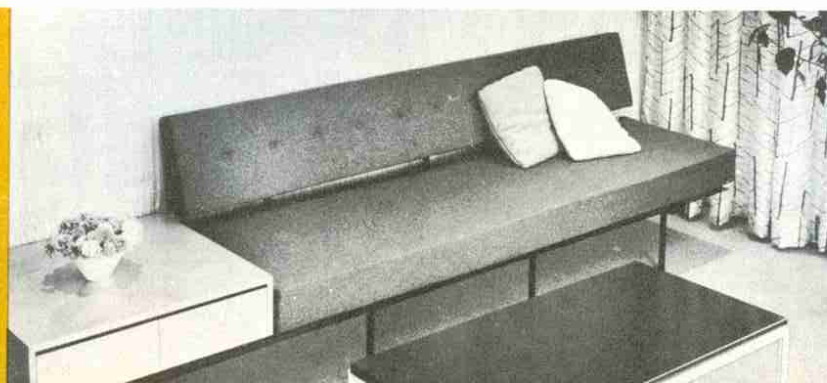
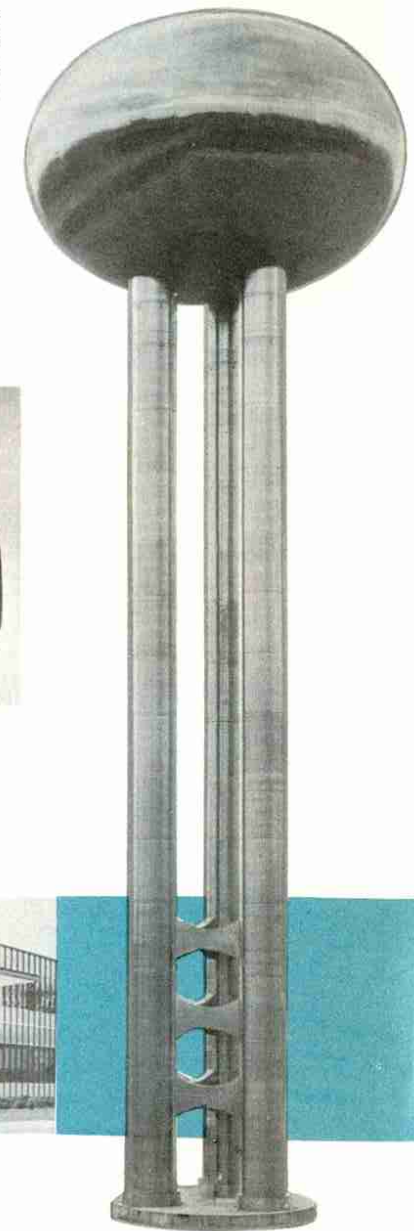

In overstuffed furniture, construction characteristics such as coil springs, padding, and wooden supports, account for its appearance. The development of foam rubber, a much thinner material, and flat automotive springs allow a new concept of design and rightfully produce new proportions. Contemporary sofa by Florence Knoll.

the FUNDAMENTALS of

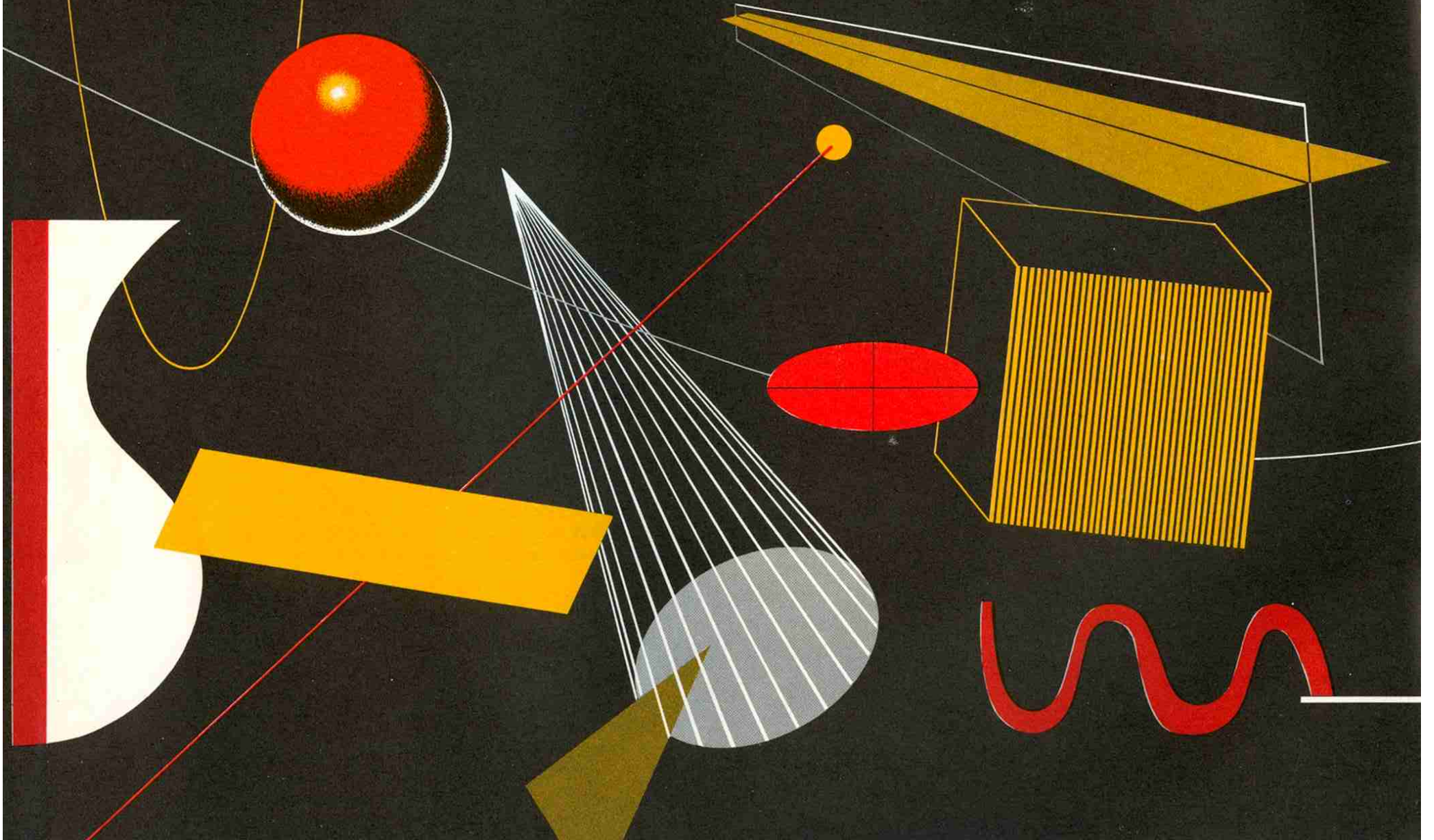

DESIGN



The Elements of Design

In preceding paragraphs we spoke of creativity in the Stylist as the ability to materialize beauty. Here then is the key to the entire activity of design and styling. How does a Stylist go about materializing his ideas? What techniques does he use? What language does he speak?

As aids in the process of developing a design, the Stylist employs two creative skills, sometimes separately, sometimes in conjunction with each other, depending on the nature of the product. First, he tests his ideas on paper. With rough sketches he establishes preliminary relationships as he begins to plan his visual organization. Then he further develops his idea in clay, plaster or wood, in the same manner as a sculptor. Although the ability to draw and to sculpture is almost standard equipment with the modern Stylist, some of the finest practicing designers cannot draw a line themselves and have little talent in clay. What they have is good taste, a

sense of proportion, a basic feeling for rhythm plus the ability to direct creative activities.

As with any means of communication, the art of design has its own language—sometimes called the language of vision.*

This special language has only four basic symbols: line, plane, form, and surface quality (which includes value, color and texture).

Any visual organization or design, regardless of how complicated or spectacular, is the result of blending these four visual ingredients.

These symbols have many interpretations. To a painter who specializes in two-dimensional design, these terms have a different significance than to the sculptor or Stylist, both of whom deal in three dimensions. Naturally, we will be influenced here by the Stylist's interpretations.

*Gyorgy Kepys, "The Language of Vision"
Paul Theobald, Publisher

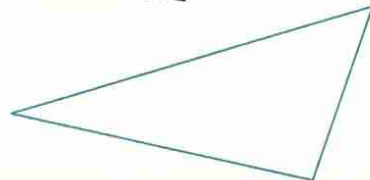
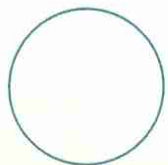
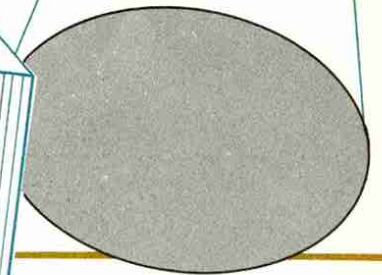
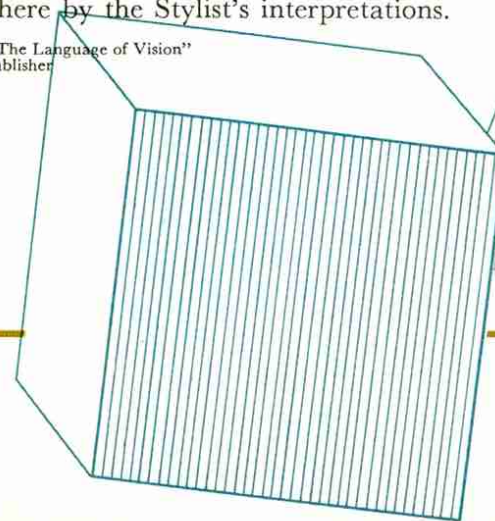
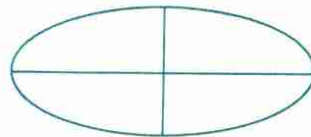
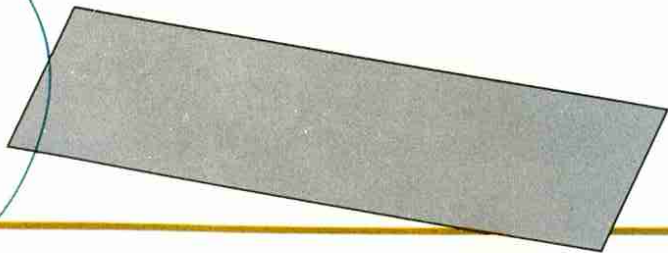
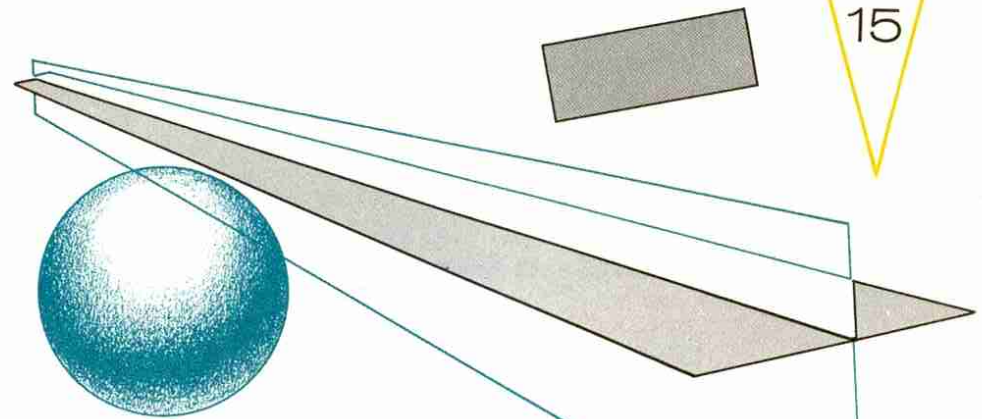

A New Line on Lines

By definition a line is the path of a point moving through space. It has only one dimension and direction is its most important property. A line carefully drawn and controlled according to some definite plan marks the beginning of visual organization, of good design.

To the Stylist, line is one of the most important of the design elements. From a practical standpoint lines are an important connecting link between the mental image and the actual desired physical shape. Lines spaced at intervals establish surfaces and control contours (see p. 55). By recording these critical lines on paper the Stylist is able to build and specify a prototype that others can reproduce.

All initial sketching and planning is done with lines—outlines, contours, openings, and intersections of planes. Lines are used to establish size relationships and to plan design themes.

If the design problem centers around a modern table, for example, in which straight lines and flat planes predominate, a line drawing tells us quite a bit about the table. We see its form and proportions quite clearly. All we need to know

further is the nature of the surfaces of which it is made.

But in a more complex object such as a pencil, a line drawing does not as completely define its appearance and form. In designing a new pencil, the Stylist would make an air brush drawing or rendering, in which the lines of construction are softened and the highlights indicated in an attempt to simulate on paper the final appearance of the pen.

The Stylist also recognizes the importance of lines as an aesthetic element in the finished design. Lines help establish proportion and create the effect the Stylist is striving for. When we speak of good lines in a beautiful object, we recognize the importance of this design element in the visual organization.

Lines not only help define and give shape to the object, but have another purpose as well. Nature causes the human eye, when inspecting a design, to skip about from one point of interest to another. Properly conceived lines lead the wandering eye back and forth across the design, adding to the interest and retaining attention. Thought of in this light, lines might be called reading aids in the same sense that the eye is said to read a design.

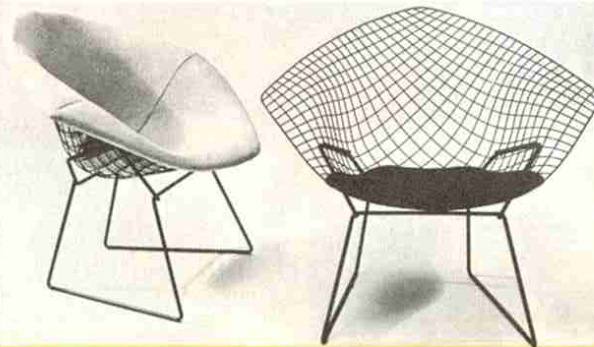

Metal sculpture (left), made especially for the cover of this booklet by GM Styling, represents an abstract use of line in a three-dimensional design. Chairs (above) by Harry Bertoia for Knoll Associates, Inc. demonstrate a practical use of intersecting lines, which the eye sees as an optical or virtual form.

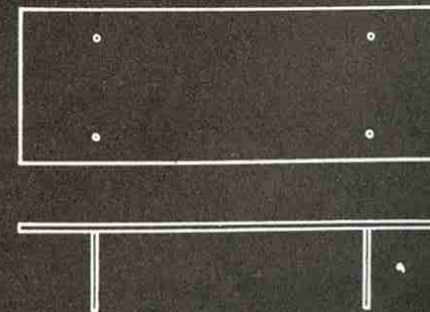

Illustrating the limitations of lines in describing three-dimensional objects. Table by LaVerne, New York and Liquid Lead Pencil by Parker Pen Company.

DIGNITY

REPOSE

ACTION

STABILITY

Planes in Space

By conventional definition, a plane is a flat, level surface which has only two dimensions, length and width, and is without thickness. The entire study of plane geometry is

devoted to the plane and to the properties and relations of such plane shapes as the circle, square, and triangle.

Since the human eye tends to slide over plane surfaces seeking points of interest, the outline or shape of a plane is one of its most important characteristics. A plane, like a line, may also have the property of direction, a fact which has been receiving considerable attention from architects in recent years.

The architect uses planes to divide living space, not in the formal sense of plaster-enclosed rooms, but as design elements which give depth, interest and flexibility to the interior.

The use of flat planes in product design is more limited, finding widest application in furniture and appliances but only infrequently in things of motion. Usefulness and practicality are the principle advantages of a plane surface.

In the mind of the modern Stylist, the concept of a plane is not limited to a flat surface. He sees a plane as a flexible thing that can curve in one or more directions. He visualizes curved planes as reflectors and modulators of light, useful in enriching a design with highlights and shadows.

"Fallingwater," the classic Kaufmann House by Frank Lloyd Wright, is a famous contemporary design in which rectilinear planes of concrete make a fascinating study in space enclosure.

Planes as two-dimensional shapes and as dynamic design elements. Tables (above) by LaVerne, New York in which shape is the most important characteristic. In the abstract (left) and practical (below) designs by students of Pratt Institute planes are used as dynamic space dividing elements, intended to cause eye movement.

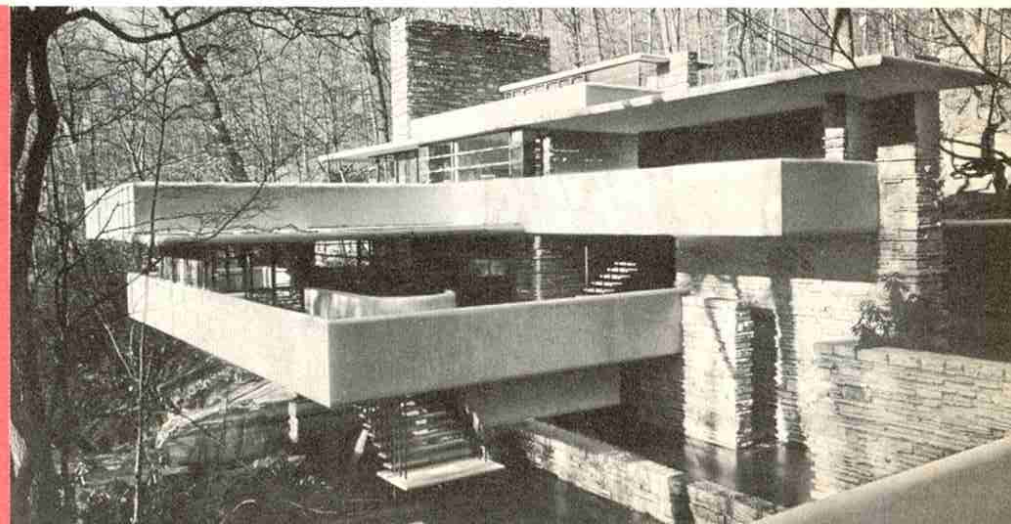
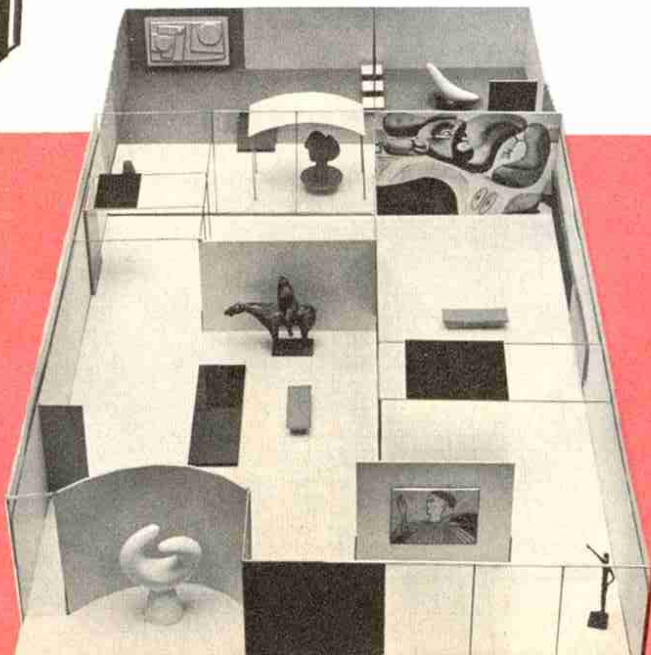
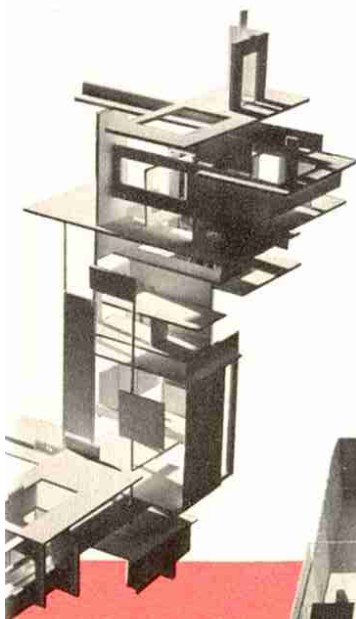



Hand sculpture by a student of Pratt Institute. An abstract form with strong tactile characteristics, it illustrates the relation between the senses of sight and touch. It is not only good to look at but pleasant to hold, as well.

Solids and Form

Strictly speaking, a solid is a three-dimensional object which occupies space. In design and styling this concept is too narrow, too mundane. The Stylist thinks, not in terms of a solid, but of a form which has identity. It may be open or closed and in addition to its exterior aspects, may also have an interior.

The important thing about any form is what is technically referred to as its plastic quality, which is the pattern of contrasting light reflections which identifies it. Curved surfaces usually predominate and the result is pleasing to the eye.

The shaping or proportioning of solids into forms is the chief business of the Stylist, just as the patterning or organizing of space is the architect's primary purpose. A form as we refer to it here is a curvilinear solid organized according to a specific plan which controls the shape, size and position of the individual parts.

how we see determines how things look

From time to time we've made reference to the human eye and how it reacts to lines and planes. We have also men-

Designs in which "form" predominates. (Left above) Curvilinear forms by Pratt Institute student. (Left) Automatic Vacuum-type Stainless Steel Coffee Brewer by Harper Richards for Cory Corporation. (Below) Fender of Pontiac Strato-Star, experimental car styled by GM Styling.

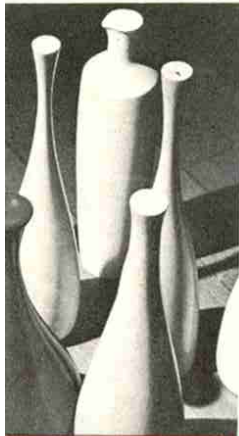

Surfaces as Light Reflectors

We are seldom conscious of seeing direct radiations of light. What we see are patterns of light reflected from the surfaces of all physical objects. These surfaces have certain qualities which aid in the perceptive process. Their influence

A camera, like the human eye, registers variations in light reflections. In this photograph we identify the egg by the high-lights and shades of gray which are variations in value. Without these contrasts recognition would be difficult.

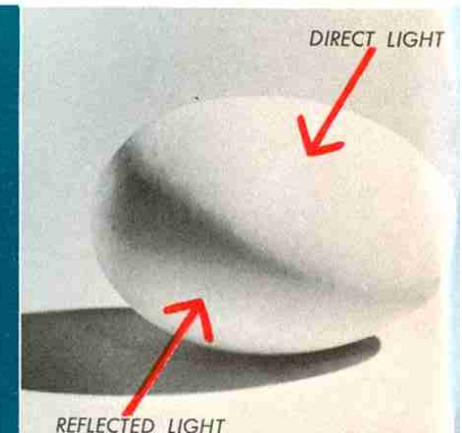

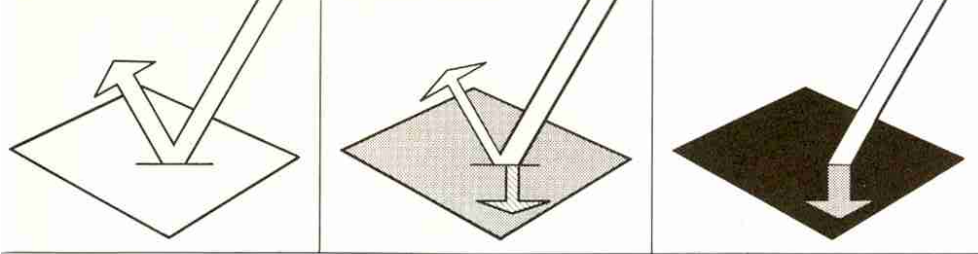

Reflection and absorption of light by white, gray and black surfaces.

is so great that we see characteristic light reflections as qualities of the object we are viewing, instead of qualities of light. That's why no one ever says, "Isn't that pattern of reflected light beautiful?"

surface value

The over-all reflective ability of a surface for all the light striking it is called value. White surfaces reflect all the light (at least theoretically) and lie at the top of the value scale. Black, with theoretically no light reflecting ability, is at the bottom with all colors and tones falling in between.

In addition surface value varies with the intensity and nearness of the light source. As we will see later color and condition of the surface also influence the light reflected.

surface texture

A second reflective quality of a surface is the property of texture. Texture is actually the pattern of contrasts in light reflections that identify the surface rather than the shape of an object. Natural textures are a result of the characteristic structure of a material, a picture of the cavities and peaks, the plateaus and valleys. Because texture is a structural element we often identify it with our sense of touch. When speaking of surface texture we often use such words as rough, smooth, or velvety which are more indicative of the feel of the surface than of the visual impact. Every material has its characteristic texture and, as a result, this property is helpful in identifying forms.

Not all textures are inherent or structural in nature. Some are the result of the method of manufacture and some are actually special surface designs.

Ten different values are represented here, ranging from white, limited by the pureness of the paper to black, a characteristic of the ink. The grays in between are mixtures of black and white carefully controlled to vary the amount of light reflected.

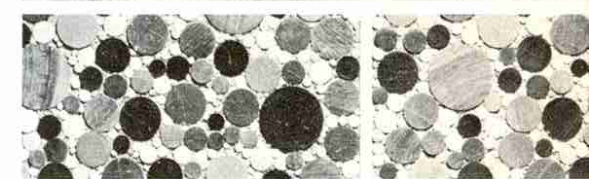
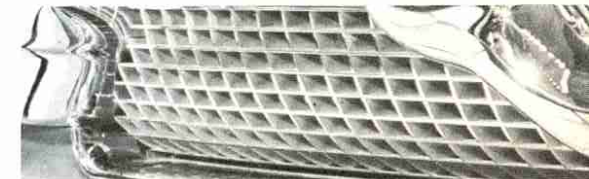
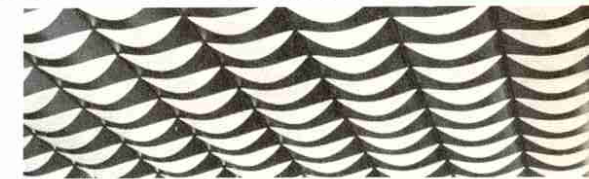
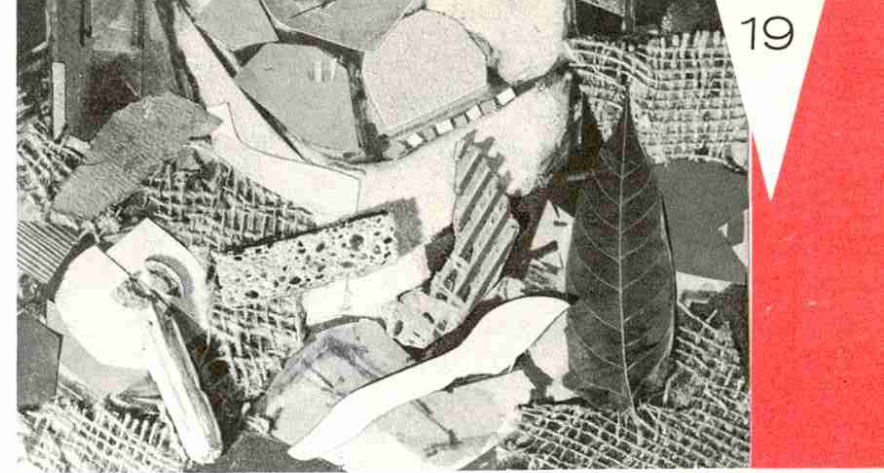

Examples of man-made textures (from top to bottom). Collage by student of Pratt Institute; Ceiling, Frigidaire Kitchen of Tomorrow (see p. 69); Grille, Cadillac Eldorado Brougham; and Wood-plug floor, Frigidaire Kitchen of Tomorrow. Interior by Knoll Associates, Inc. (Below) is a fascinating example of how a variety of subtle textures can be used to advantage.

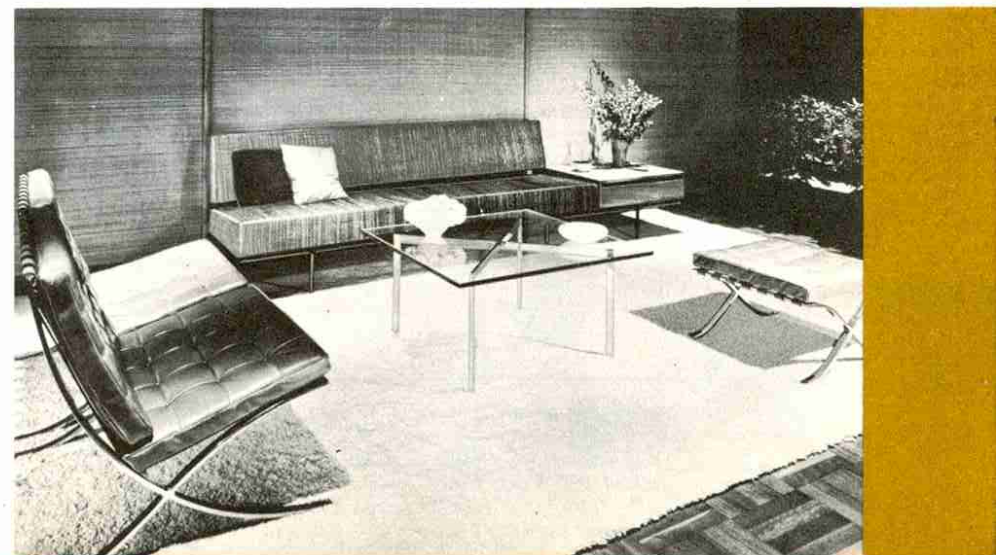

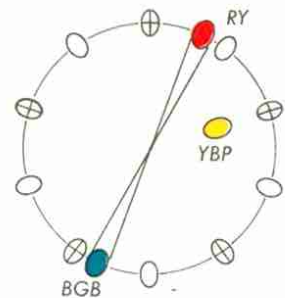
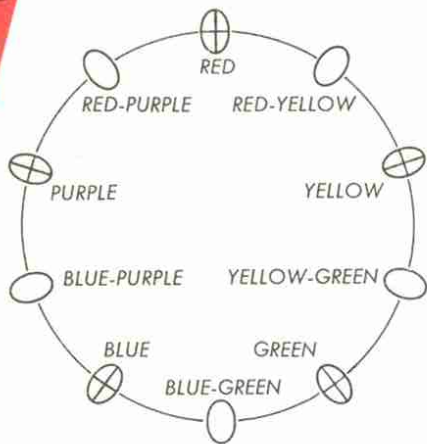

Shown here is a color wheel based on the widely used Munsell color system. Five primary and five secondary colors or hues are indicated. Pairs of adjacent colors on this wheel are known technically as "harmonious" hues; colors opposite to each other are complementaries. (Above) the three colors used in this booklet are located properly on the color wheel: a grayed yellow (yellow blue-purple); a red-yellow; and its complementary, blue green-blue.

surface color

All of us realize if we stop to think about it that "white" or natural light is made up of all the colors of the rainbow. When we see a rainbow it is a separation of natural light into various colors by the atmosphere.

Many surfaces act as selective filters to the color components of natural light, reflecting some, absorbing others. The ability of a surface to reflect a pure or spectrum color to the exclusion of others is called hue. Red, yellow, green, blue and purple and their intermediate colors are hues. Natural light falling on a surface covered with red pigment, for example, is reflected as red. All other light rays are absorbed.

Some types of surfaces are not so selective, but reflect a combination of colors which the eye sees as a neutralized color. This type of surface is said to reflect less than the maximum intensity or purity of color.

The art of controlling surface color has been carefully studied by the Stylist as a means of increasing contrast and adding interest to a design. He rates color as a design element

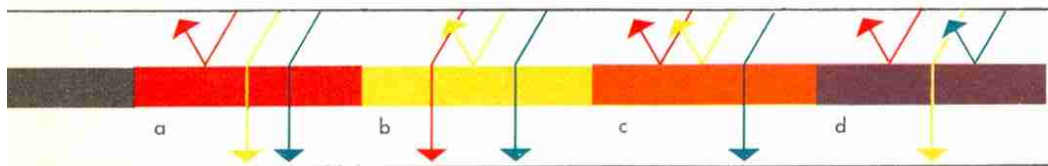

Schematic drawing showing various color selective surfaces: (a) a primary hue (red); (b) another primary hue (yellow); (c) a secondary hue (mixture of red and yellow); (d) a mixture of complementaries (red and blue). Note that booklet colors have been used to represent primary hues.

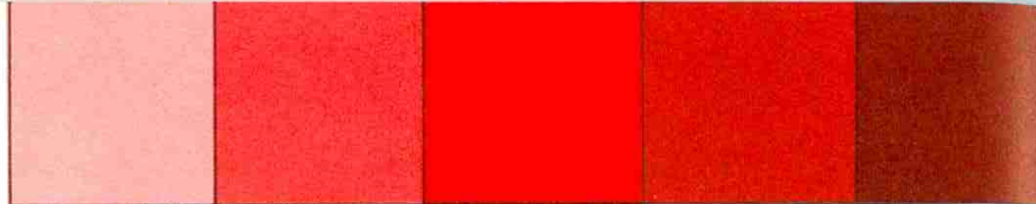

Tints—Red + White

Shades—Red + Black

Starting with one hue, red, the chart at right shows how a color's value may be changed (top row) by adding white to make tints or black to make shades. Mixing red with its complementary, blue, in various proportions reduces its intensity.

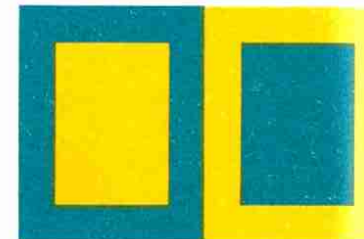

The enlarging and diminishing effect of color on the size relationship of adjoining areas.



A harmonious color scheme using closely allied hues.



A complementary color scheme using opposing hues.



NEUTRAL

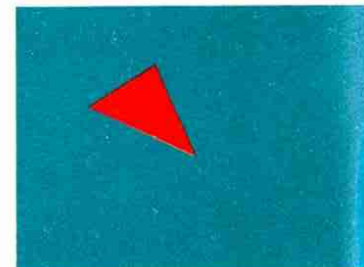

The advancing effect of red and the receding effect of blue when used together.

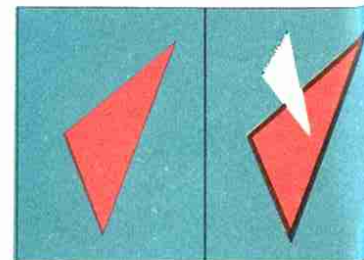

The use of white, gray or black helps harmonize two colors lacking in contrast.



An effective color scheme is characterized by contrast in one or more of the following: hue, value, chroma and area. In the sketch at left variety of hue (red, yellow and blue), value (white, light blue, dark blue, red and dark red), intensity (yellow and grayed yellow, red and grayed red) and area are illustrated.

second only to line and form. The mixing and blending of pigments (color selective materials) is a highly complicated subject, too involved for discussion here.

the meaning of color

Our individual reaction to colors is often based on past associations. By frequent identification with some idea, faith, or personal experience, a color comes to be symbolic. This explains why we usually associate purple with royalty; greenish yellow with sickness and disease; blue with atmosphere; green with freshness and youth; and white with purity.

During recent years we've come to realize that these associations are not necessarily valid. Any color, if used properly, can have great aesthetic appeal, a fact that is apparent in the recent use of more vivid and varied colors in our clothing, homes and automobiles. In addition to its aesthetic appeal, color has a definite effect on other design elements.

Certain combinations of color, for example, change the apparent size relationship of adjoining areas or masses. In the drawings at the left you can see one effect of this optical illusion. Although both rectangular shapes are exactly the same size, that on the left appears much larger.

Another type of illusion produced by color is an advancing and receding effect. When red, a warm, advancing color, is used with blue, a cold receding color, a three-dimensional effect is produced.

The Principles of Design

Someone has said that a beautiful painting is to be looked at, not talked about, a saying that reflects the difficulty of putting into words the same emotions and aims that exist in the visual artistry. It is also difficult for a professional Stylist to describe the points of superiority in a good industrial design. How can you pluck one part from the whole and consider it as a separate entity? It's almost impossible to break a design into components or to put into words the method of organization that holds it together.

We can generalize, however, about some of the characteristics common to most good designs. Among these are unity, variety, balance, proportion, and rhythm, the principles by which the four elements of design are bound together.

Unity and Variety

Unity and variety are the means by which we analyze the over-all effect of a design. If a design has unity we mean that everything in it is woven together, according to some well laid plan. The functional and aesthetic relationships are combined and balanced to make a complete self-contained design. Another name for unity is harmony.

Just as important to the success of the design is variety, which means the use of contrasting elements so controlled and placed as to hold and retain our attention. Variety means interest, the opposite of monotony.

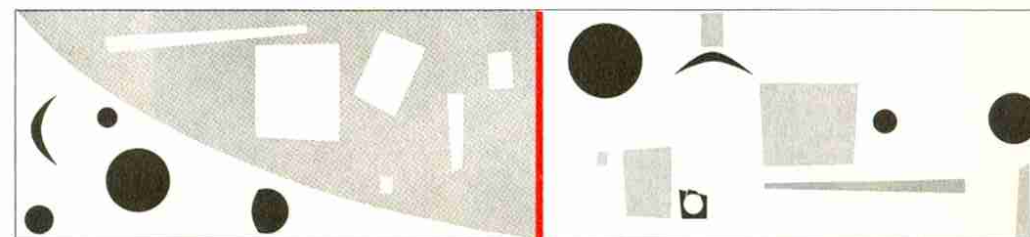

LACK OF UNITY

UNITY

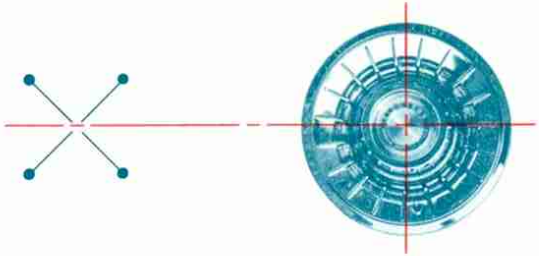

Balance and Symmetry

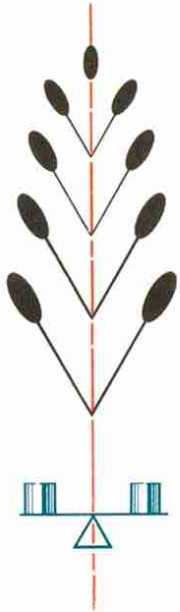

Have you ever wondered about balance in physical things? Why are most living organisms symmetrical about an axis, almost exactly the same on the right side as on the left? This orderly arrangement springs from nature's law of equilibrium which is based on gravitational pull.

As individuals we are always in a state of equilibrium thanks to two mechanisms in our ears which tell us where our center of gravity is. Balance is not only a biological necessity in our own make-up but we also look for balance in all visual objects. What's more, we are able to recognize this property when we see it. Balance we can "see" is known as optical balance. When the two halves of an object are exactly alike on either side of an axis the relation is known as formal symmetry. A design can also be symmetrical when organized radially around a center point. Wheel discs in the automobile are good examples of radial symmetry.

Balance need not be a strictly formal arrangement however. There is such a thing as informal symmetry in which we perceive balance just as surely as in formal symmetry.

Notice in your own perception how your eyes judge balance in everything you inspect. Without trying you note the center of gravity, judge the delicacy of the balance.

Abstract example of informal symmetry.

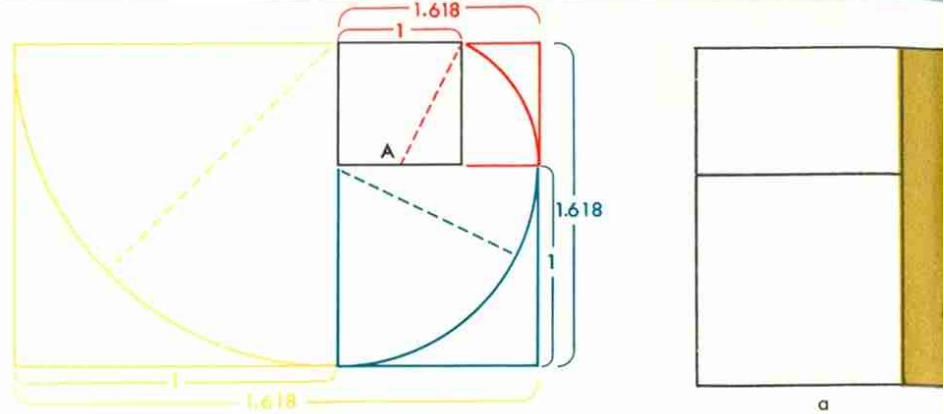
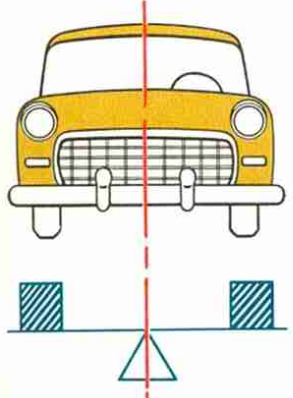
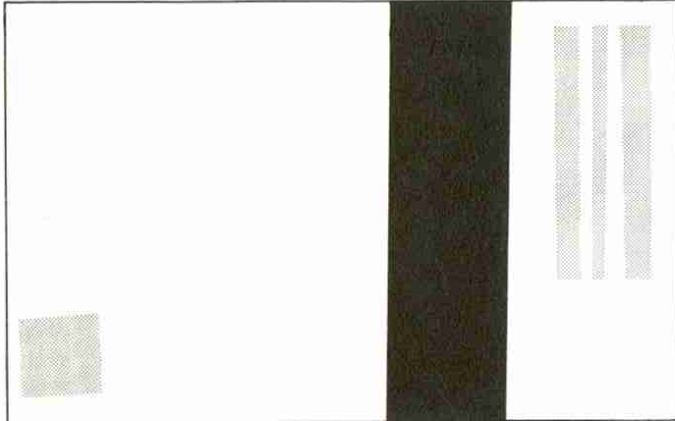

The "Golden Mean Rectangle" was devised by the ancient Greeks as a useful tool in proportioning their beautiful buildings. Starting with a square, a radius (red dotted line) is drawn about point A which bisects the side of the square. The sides of the rectangle thus formed have proportions of 1.618 to 1. The long side of this rectangle and each succeeding rectangle becomes a radius which, when extended, forms a new rectangle of similar proportions. The result is a series of shapes which combine rhythm and variety.

Proportion

Proportion means the size relation of one portion to another, or of one part to the whole. In a sense proportion is the same as ratio, except that it has a broader meaning.

In design, proportion is one of the most effective means of creating unity among the various components. The use of proportionate elements, whether of lines, dimensions, areas, masses or colors, helps establish a feeling of rhythm and unity, binding all the elements together into a whole so tightly that removing or altering any single part would disturb the whole design.

Since, in discussing proportion, we are dealing with quantities and ratios of quantities, it is not surprising that there

Optical balance in a bus which the eye perceives as surely as true symmetry.

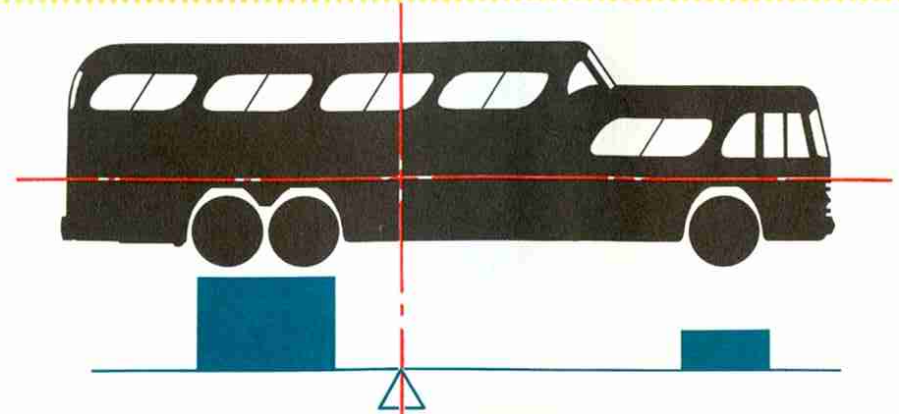

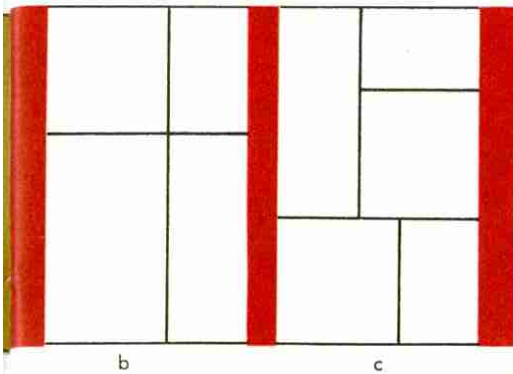

(Above) Division (a) and sub-divisions (b) of area by Golden Mean. In (c) the areas from (b) have been rearranged. (Right) Contemporary Room Divider by Paul McCobb for Calvin Furniture Company is an example of how a designer intuitively arrives at a proportionate relationship similar to the Golden Mean.



are mathematical formulas which seem to coincide with the result the designer is aiming for.

It has been said that design is the visualization of geometry. As a matter of fact many of the famous artists, architects and designers of the past have built their designs around mathematical relationships. Although it is interesting to point out one of these relationships (see cut), let's keep in mind that good proportion is a relative thing, meaningful only when based on function, materials and technique. Proportions are said to be good when all factors are balanced. A change in any element also changes the concept of what is good proportion, and it need not be based on any theory.

Rhythm

"I got rhythm, you got rhythm . . . who could ask for anything more?" Thus begins George Gershwin's catchy song of the 1930's. No truer words were ever spoken. Everyone has rhythm in their make-up. We walk and talk in rhythmic pattern. Our hearts beat and our lungs expand and contract according to a predetermined rhythm. We are creatures of rhythm and we live in a universe that is governed by some

interconnected rhythm of recurrence. Night and day, summer and winter, development of the individual, the passing of generations all fall into a definite rhythmic pattern.

Rhythm in design, as in music, is marked by a regular occurrence of, or alteration in, features or elements. In music the intervals are of time; in design the intervals are arrangements which cause eye movements. It is the nature of rhythm to be recurring in a regular manner so that you can depend on it, you expect it.

A good popular rhythm in music soon strikes a responsive chord within us and sets our feet to tapping. We want to dance and respond to the rhythm. In classical music it takes study before we can recognize and respond to its highly complicated rhythms. This is true of design also. Simple rhythms in which progressively larger or alternating large and small elements figure are easily recognized. In complicated designs, combinations of line, shape, size, and texture may recur in rhythmic fashion and careful analysis may be necessary to perceive and understand the basic rhythm. It is evident that there is a close relationship between the principles of rhythm and proportion. By the similar proportioning of various components according to a basic pattern a complex progressive rhythm can be established.

The use of rhythm in architectural design. Y. M. C. A. Building, Racine, Wisconsin. Maynard W. Meyer & Associates, architect. Glass Block by Pittsburgh Corning Corporation.

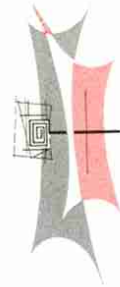

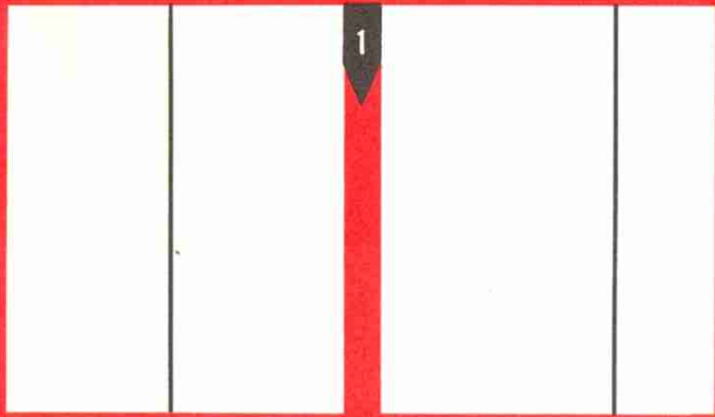

A

B

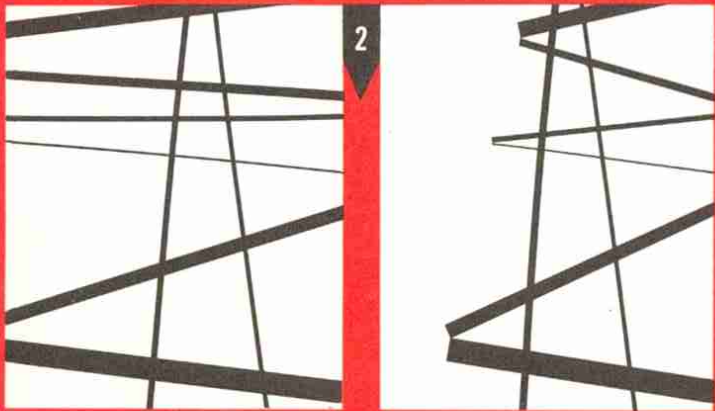

A

B

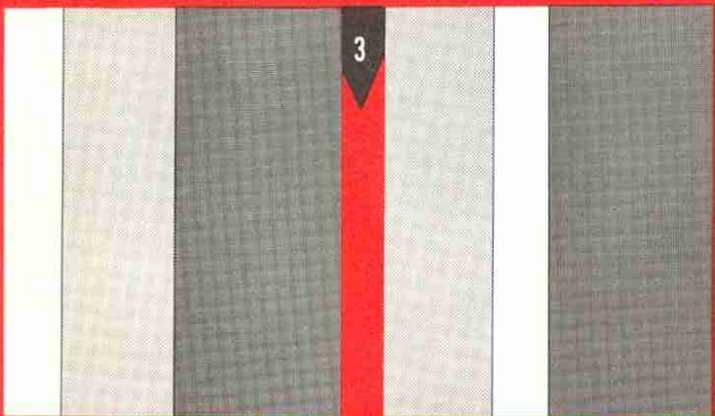

A

B

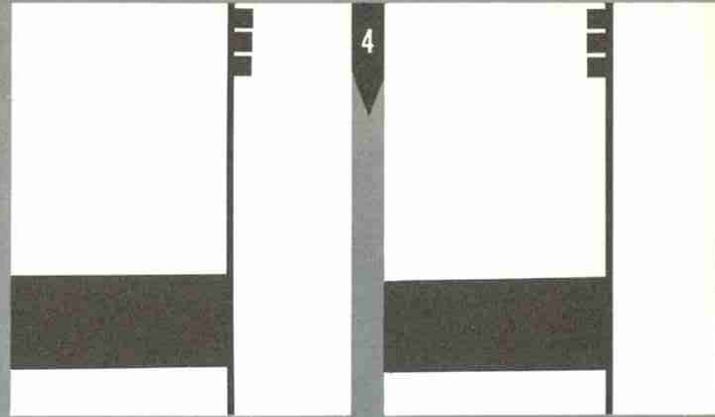

A

B

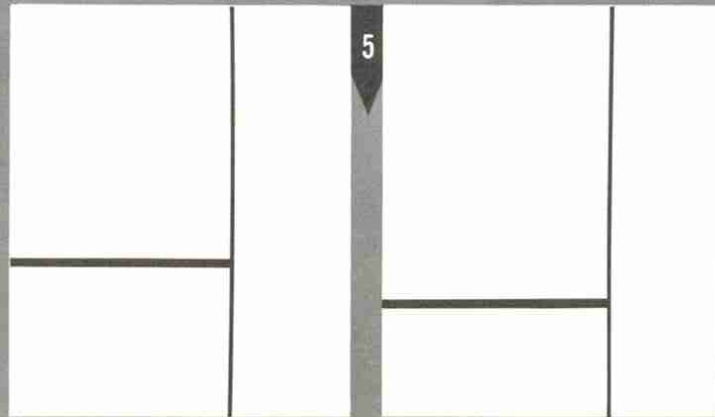

A

B

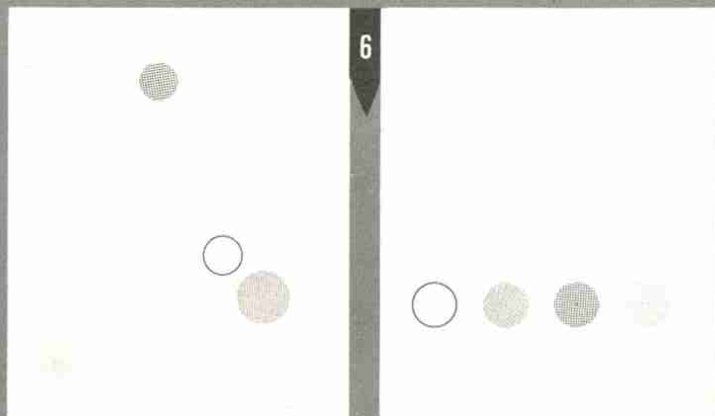

A

B

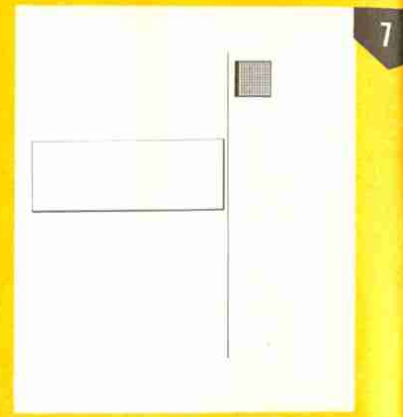

A

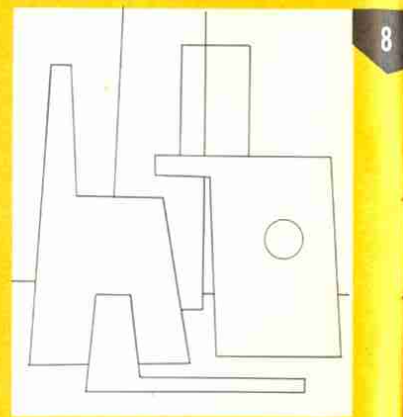

A

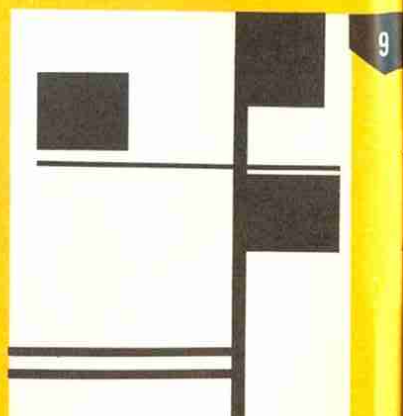

A

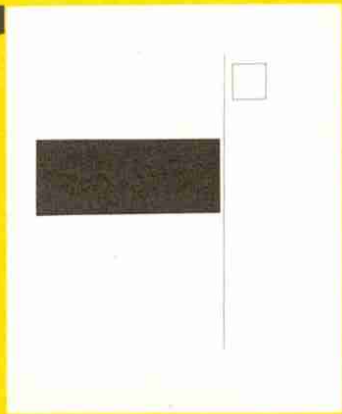

B

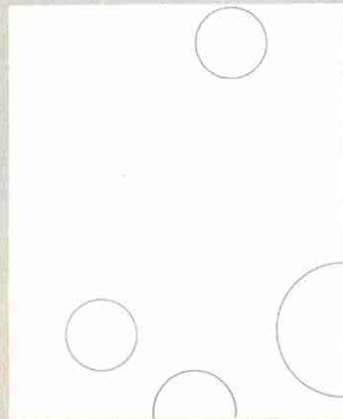

A

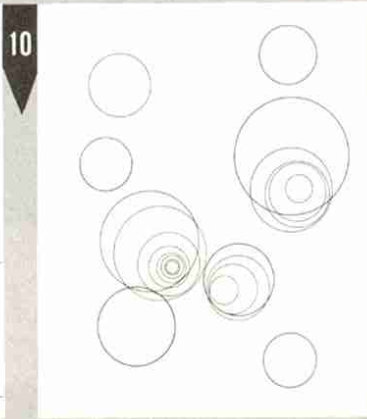

B

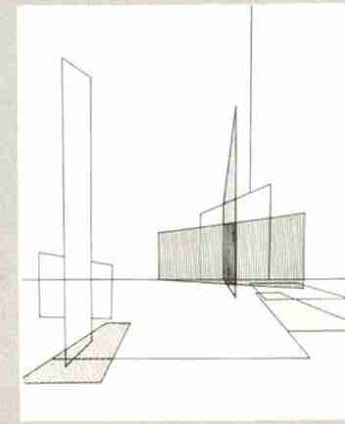

A

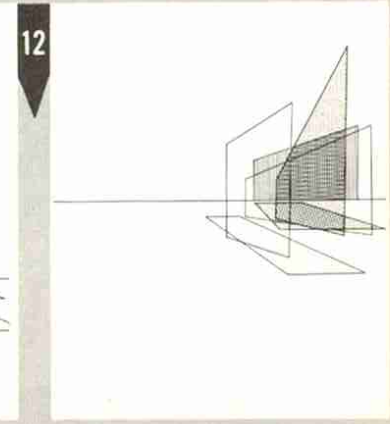

B

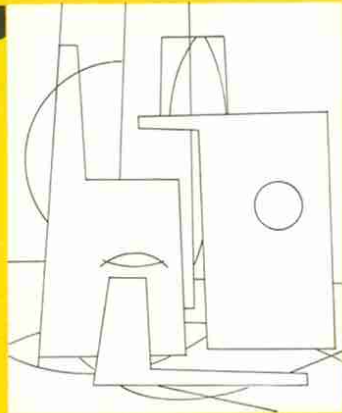

B

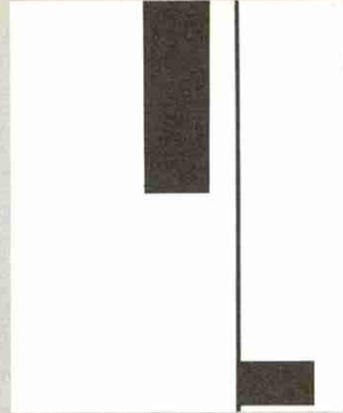

A

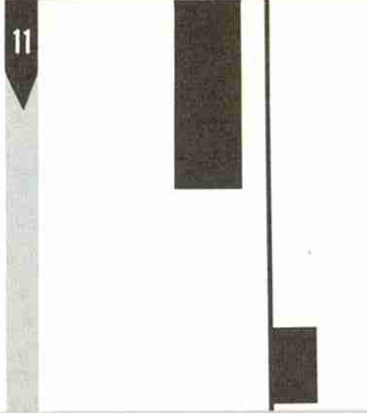

B



A

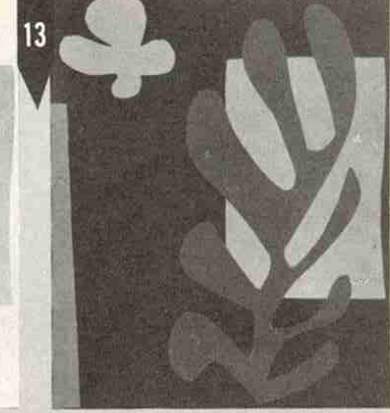

B

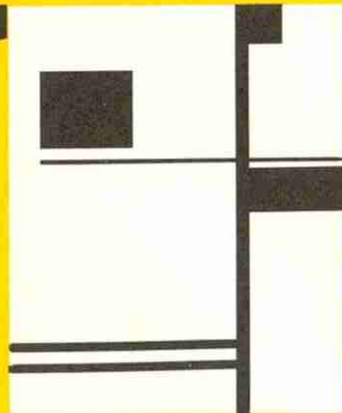

B

Compare Your Design Taste with the Experts

Here is a test that you can take just for fun to see how your design taste compares with the experts. These drawings have been prepared at the request of General Motors Styling by advanced students of industrial design at Pratt Institute, Brooklyn, New York. As you examine the designs, keep in mind that none of them has any relation to familiar objects or recognizable patterns in your everyday life. Each pair of drawings simply represents one good and one bad solution of some fundamental design problem. It may be the subdivision of a plane surface as is the case in the first example. Greater interest generally results if the division is uneven, as opposed to an even division which is considered monotonous.

Bear in mind that only simple lines and shapes have been used in these exercises and that each problem centers around

arranging these specific elements within the confines of a rectangle in such a way as to illustrate a specific principle.

Place a check mark beside each drawing of your choice among the thirteen sets. Then turn to page 47 for an explanation of the principle involved and the experts' choice. Although you may not "like" the preferred choice as well, we hope that after reading the answers you will have a better understanding of the principles involved.

After totaling up the number of correct choices you have made, multiply this number by three. A score of 36-39 shows an excellent grasp of the fundamentals illustrated; 30-33 is good; and 24-27 is fair. Please remember that this is not an I.Q. test for design ability, but another way of pointing out the use of the principles of design.



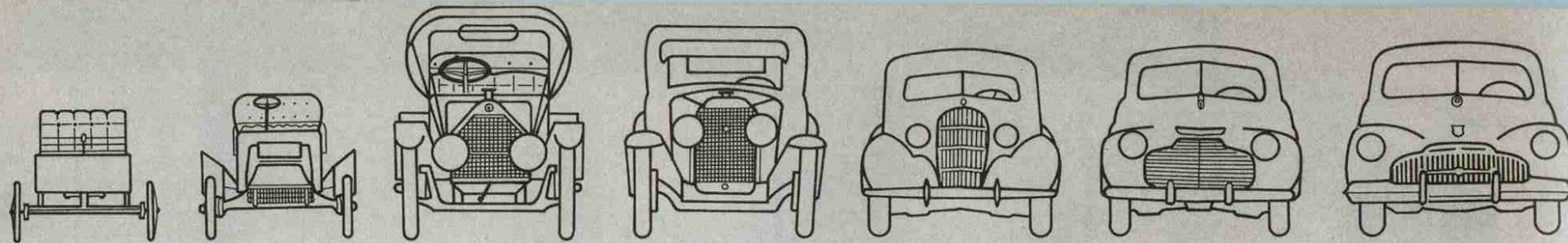

Evolution of Design in the American

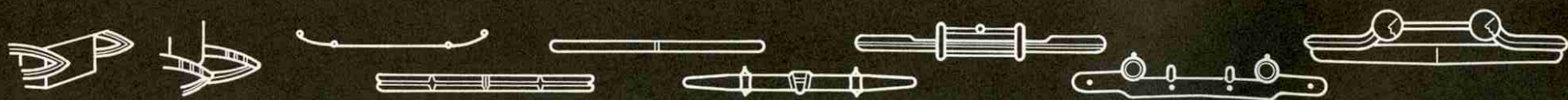
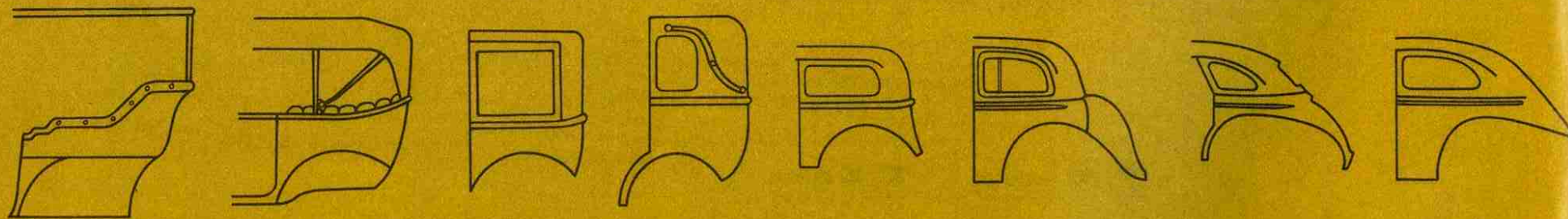
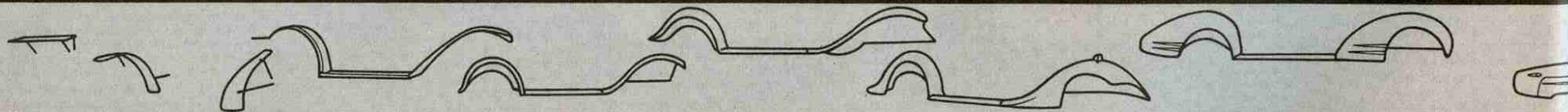
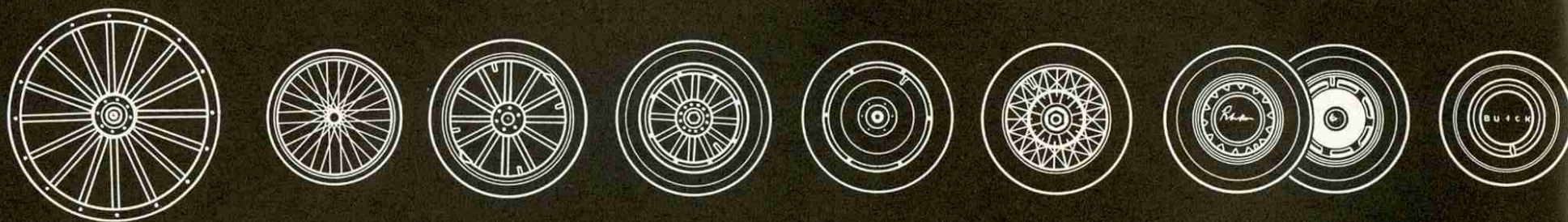
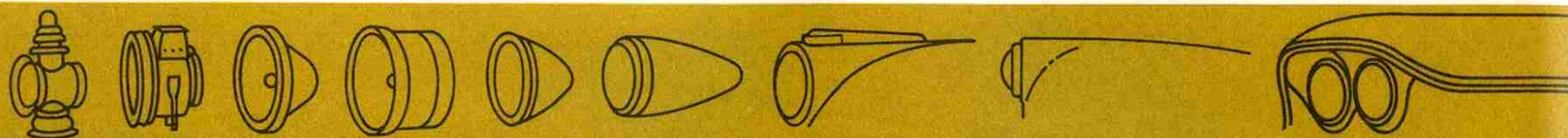

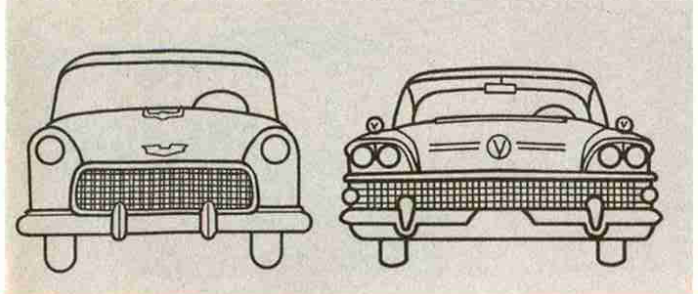

Automobile

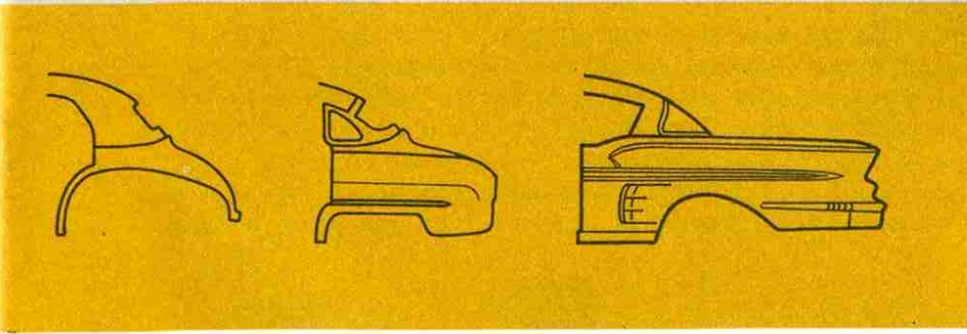
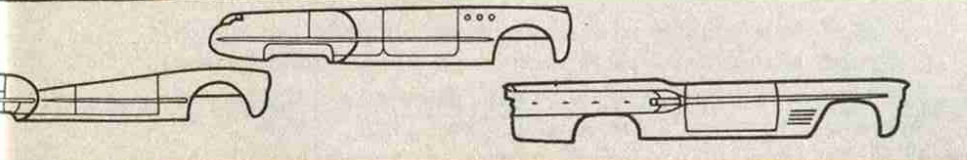
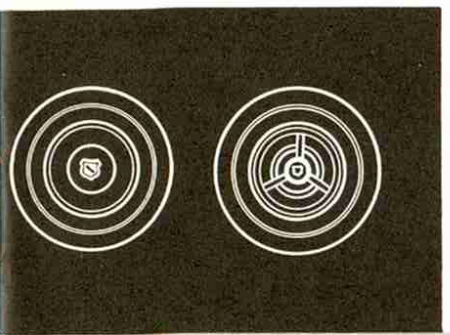
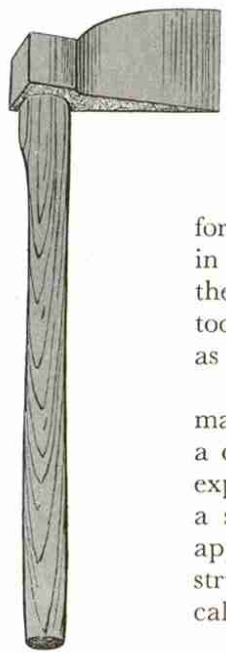

Every useful object that ever contributed to human comfort and welfare has gone through a characteristic evolution in appearance. In the successive stages of this development there is a marked similarity whether the object is a simple tool like a hatchet or a highly complicated mechanism such as the automobile.

First comes a specific need, which is usually shared by many people. This is followed by invention—the building of a crude but workable device that fills the need. Then with experience and the development of greater knowledge comes a series of refinements. Eventually, by trial and error, by application of scientific principles to the problem, a basic structure is produced that can scarcely be improved mechanically, or so it seems at the time.

In the case of this simple tool, the hatchet, its outward form has been a natural outgrowth of the conditions under which it is used and the materials of which it is made. But in the case of the highly complicated mechanism, the automobile, the factors which affect its appearance are more numerous. As a result, the evolution of its appearance is more difficult to trace.

As such things as utility, reliability and convenience gradually become accepted facts, the factor of appearance assumes increased importance. Maker and user alike become appearance conscious. Decorations, artistic lines, new concepts of appearance make one stand out over the others. Aesthetic appeal becomes basic to the desirability of the tool, whetting the desire to own and increasing the satisfaction of ownership.

How the American automobile went through this process of change and why it looked as it did in various stages is outlined on the following pages.

The American gasoline automobiles shown here are representative production models. They have style features and body characteristics that were typical of the period and which were found on other contemporary automobiles.

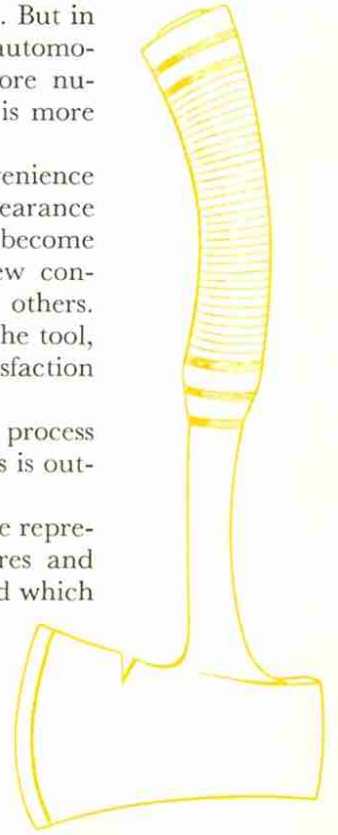

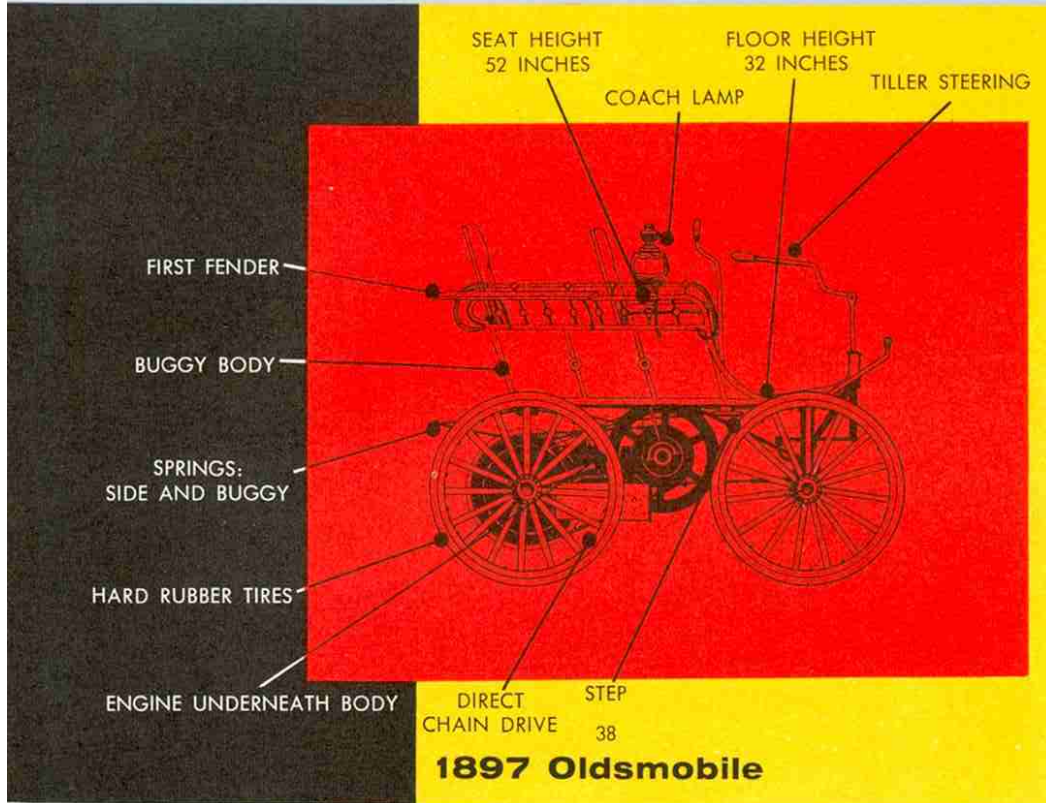

any new product, they were more concerned with “function” or performance.

They were fascinated by the idea of a four-wheeled vehicle driven by a self-contained power unit, an idea that thrills a lot of people even today. Most of their energies were engaged in making a workable machine, which meant solving many new and complicated problems.

Remember, such commonplace things as ignition, carburetion, steering, power transmission, etc. were as yet in an early stage of development. Machine tools were comparatively crude. The steel industry was in its infancy and thin gauge sheets were practically unknown. The universal building material was wood; poplar for sheathing and ash for supporting members. Inadequate stables and blacksmith shops were of necessity the scenes of their first efforts.

If we think about it for a moment, it’s not surprising that these pioneers used wagon and carriage bodies as the foundations on which to build their runabouts and touring cars. In addition to being readily available and inexpensive, this type of body offered excellent support for an engine and transmission.

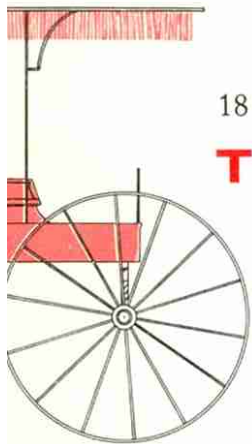

1895 - 1904

The Beginning: A Modified Carriage

The men who, around the turn of the century, undertook the task of building America’s first automobiles knew little or nothing about styling as we think of it today. Their interest in appearance centered around such features as beauty of finish and quality of hand workmanship. As with the inventors of

why so high?

All of these vehicles were exceptionally high by our standards, and naturally so, since they had been designed so that the driver could see over the horse. But that’s only part of the reason for their great height. Extra large wheels, 36 to 42 inches in diameter, were necessary to travel through the deeply rutted and muddy roads so common at the time. In addition to raising the body above the mud, these large wheels required less pulling power of the horses. Also contributing to the overall height was the manner of laying the springs over the axles.

Without the familiar and beloved horse out front, a big segment of the public felt something was missing. Hence the

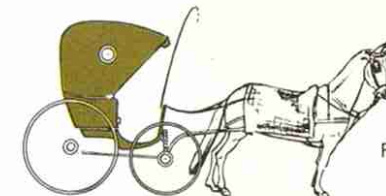

PHYSICIAN'S PHAETON
WITH CAPE TOP

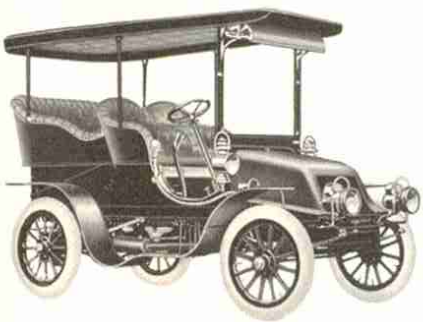

1903 Model "A" Ford, a predecessor of the famous Model "T" at a time when the automobile was called mechanical carriage, automatic buggy and petroleum wagon, as well as "horseless carriage."

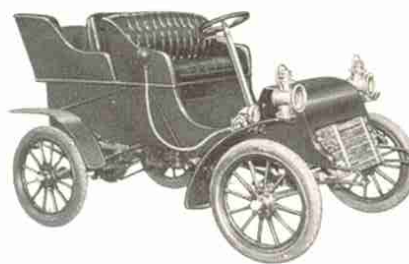

1904 Oldsmobile Runabout, first mass-produced American gasoline automobile and subject of the famous song, "In My Merry Oldsmobile." Its distinctive curved dash, pleasing lines and low price made it the most popular car of its day.

1904 Winton. Its rear-entrance tonneau, a feature imported from France for short-wheelbase bodies, didn't last long in the U.S. The canopy top, sun visor and graceful curving mud guards were early attempts at styling.



1902 Cadillac with removable tonneau. The copper-disc radiator in front of the dash was a novelty which preceded the engine-in-front models.

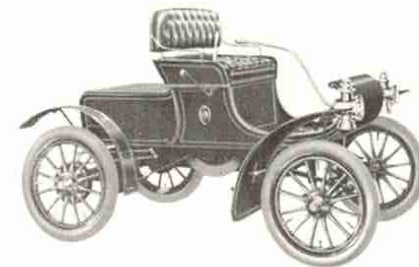

famous nickname, "Horseless Carriage." A few sentimentalists felt so badly that they proposed mounting a horse's head in front of the dash and using reins to control the steering mechanism instead of a tiller or lever. But to a lot of people, the spectacularly noisy "one lungers" (single cylinder engines) were exciting and desirable.

1905 - 1911

The Transformation to Automobile Starts

The efforts of the first car makers were so well received that hundreds of new companies were formed, thousands of dollars in capital raised, and numerous manufacturing plants constructed. The trend was to bigger, more expensive cars: the short runabout was replaced by the longer touring car; the one-lunger by more efficient, more powerful two-cylinder engines. At first wealthy people and sportsmen were the principal customers.

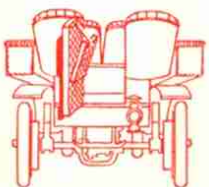
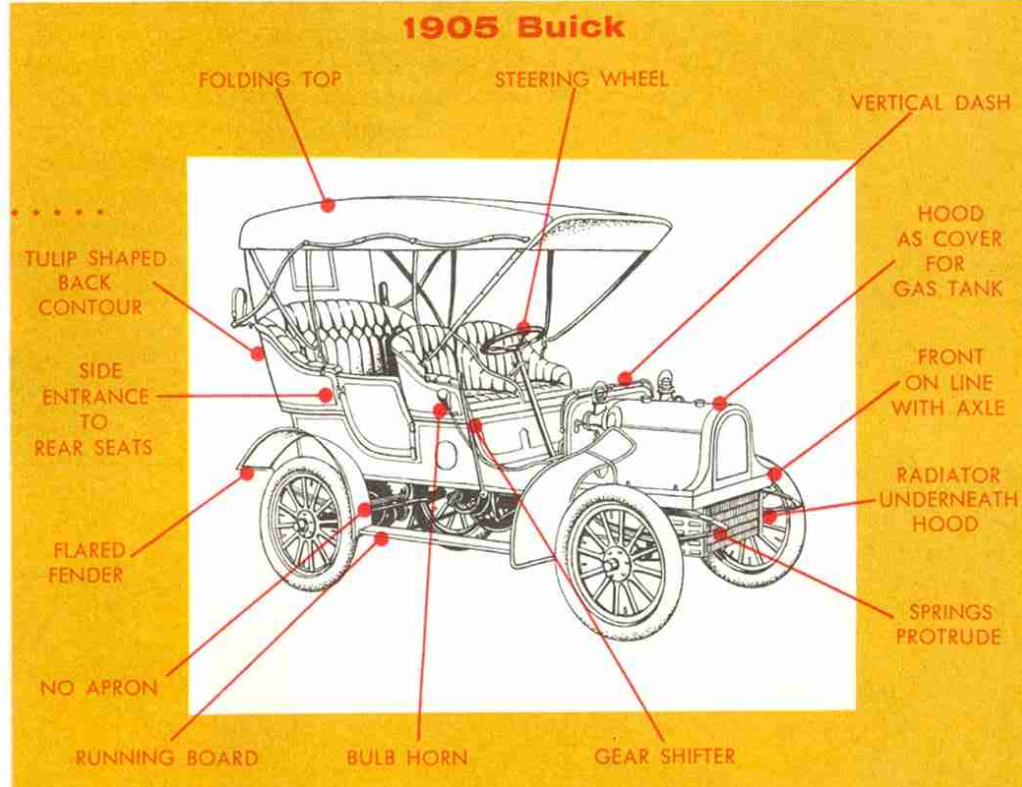

REAR ENTRANCE TONNEAU

Clad in wood and upholstered in leather the stately rear seats shown below were the high-style body features of the day.

OGEE

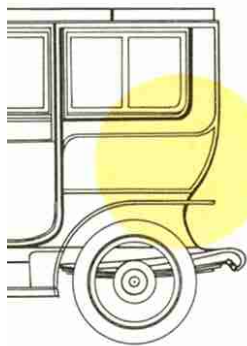

TULIP

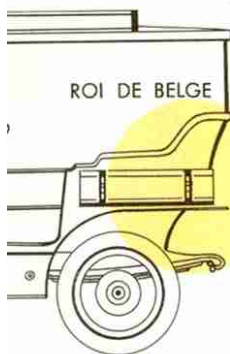

OGEE

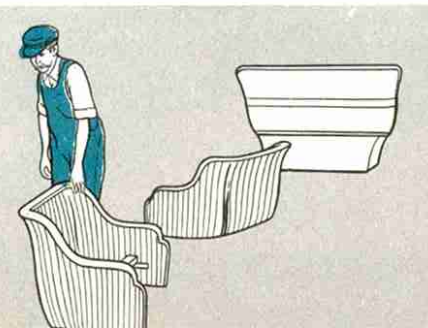
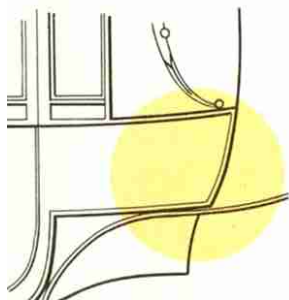

All-wood construction. Early bodies were sheathed in narrow, flexible strips of poplar.

1910 Stevens-Duryea. Long wheelbase, unusual windshield and engine out front were featured. Note prominence of hand brake, bulb horn, spare tire, acetylene headlights and tool box.

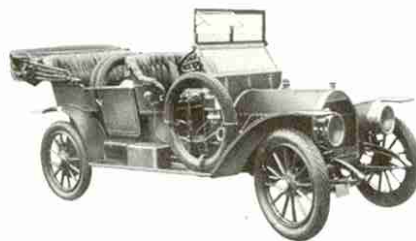

1910 Oldsmobile Roadster. The fender line, folding-top supports, vertical windshield above dash, and cylindrical gas tank were typical of the period.

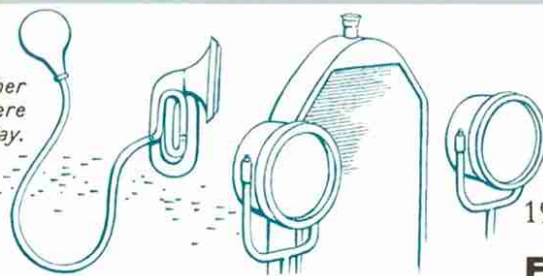
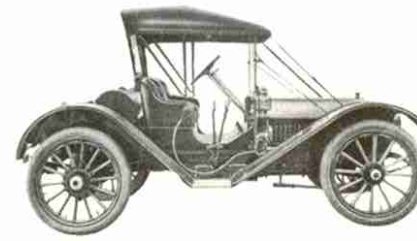

1912 - 1918

Flush-Side Body and 'Ogee' Cowl

During the next decade the automobile industry grew by leaps and bounds. Cars came to be made by the hundreds of thousands. Mass production techniques were introduced; the modern assembly line made its debut; and the interchangeability of parts became a reality as new standards of accuracy were established.

In the process, the automobile outgrew its first role on the American scene as a rich man's toy and became an economical means of conveyance for the average American family.

During this period, the design of the body was in the hands of old-time carriage builders, coach makers, and relatively new body engineers. Stylists did not enter the picture for another ten years.

By 1912, most of the "horseless carriage" features had disappeared. The body of the touring car had undergone a metamorphosis from a supporting member, as it had been in the past, to a containing unit which housed other parts of the automobile.

Doors, now installed at both front and rear entrance ways, were flush with the body surface and in line with the top of the body. Hence the name "flush-side" body. Seats, for the first time, appeared to be installed within the body and the distinctive lines of the Continental rear end disappeared to be replaced by the contours shown on the opposite page.

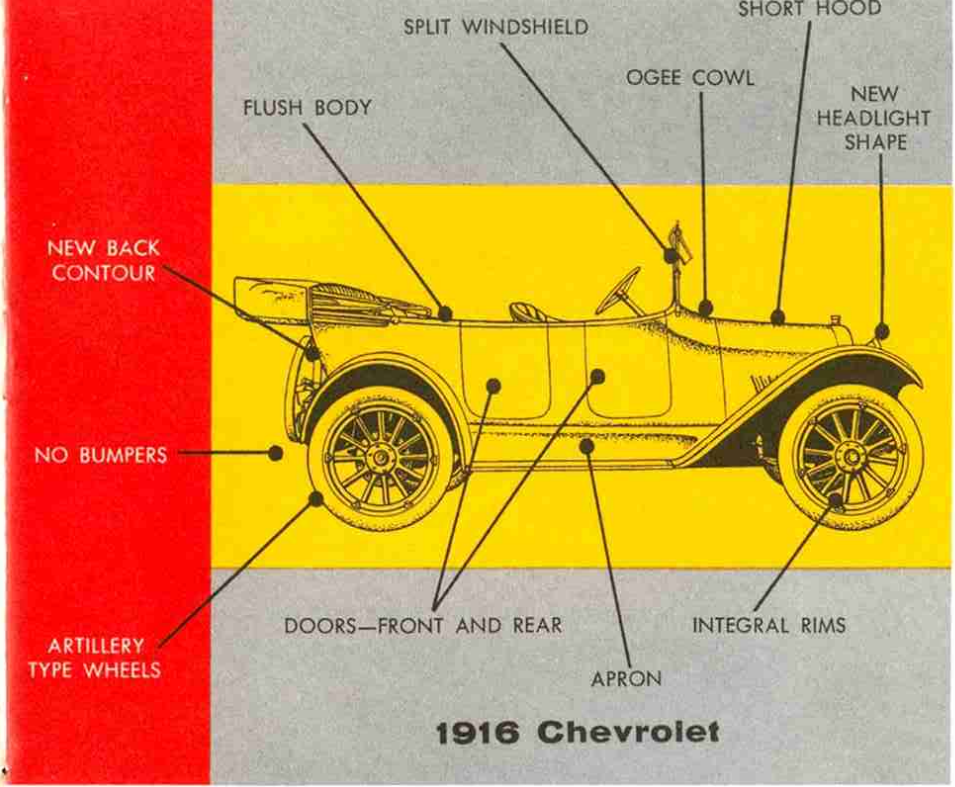

1916 Chevrolet

1913 Peerless. Doors to both front and rear seats; divided windshield and long 5-sided hood were typical of the period. Electric headlights and front bumper were advanced.

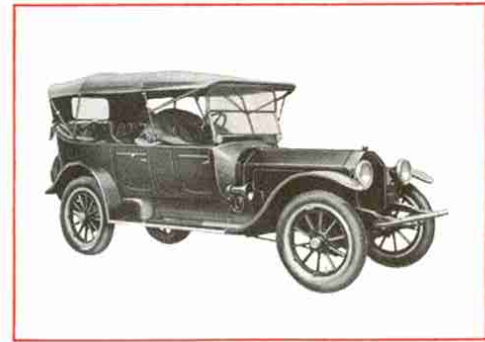

1917 Franklin. Its distinctive hood design was possible because the Franklin engine was air cooled and required no radiator. It was one of the few cars to use a laminated wood chassis frame.

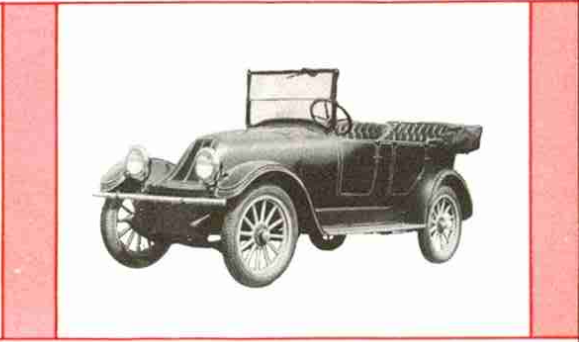

S-curve. A distinguishing characteristic of the automobile for more than a dozen years, this new arrangement was a logical attempt to bring about an integration of body and engine compartment.

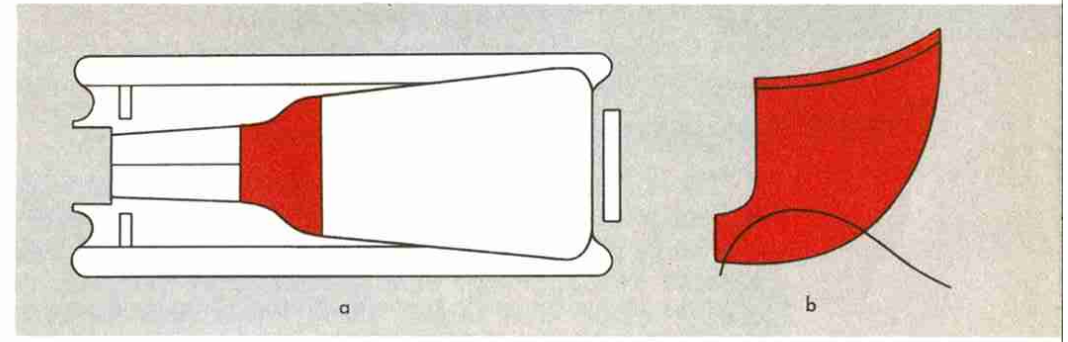

Typical body design of 1912. Viewed from the top (a) the reverse curve of the "ogee" cowl can be seen clearly. In the shape of the back (b) is evident the influence of the parlor sofa.

And see what happened to the familiar dash panel, the vertical partition that separated the passenger compartment from the motor space. It, too, disappeared beneath a curved cowl which sloped down from the windshield to meet a shortened hood. The dash, or shroud as it is now called, still marks the front of the body proper.

The new cowl was termed "ogee" because of its similarity to ogee architectural moldings which had the same reverse or

Wood and metal construction. After 1907, the hardwood frames were sheathed in sheets of aluminum or steel. Wood and metal joints were covered by aluminum moldings.

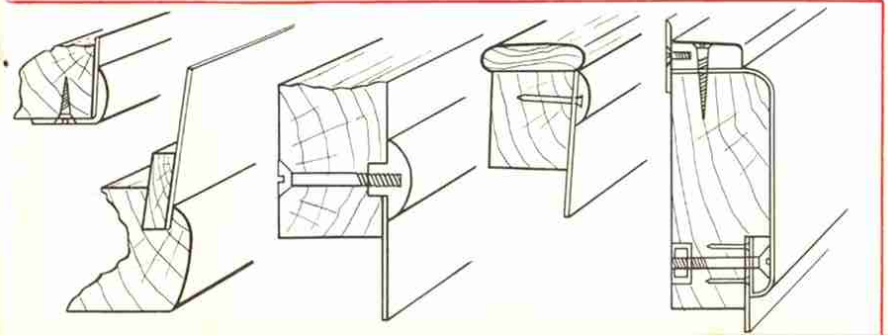

1913 Model "T" Ford. Although yearly models were unknown, many manufacturers made frequent changes. Henry Ford, however, in setting up production for the Model "T" decided to retain the same basic model and concentrate on lower unit costs.

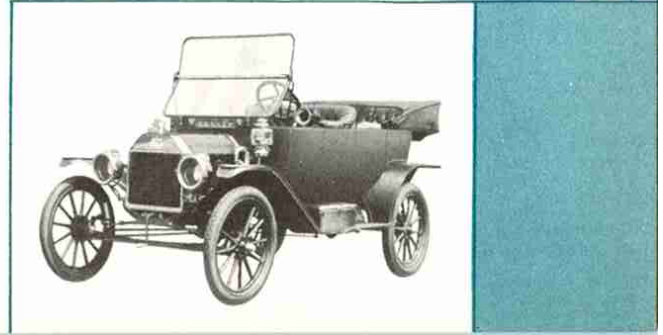

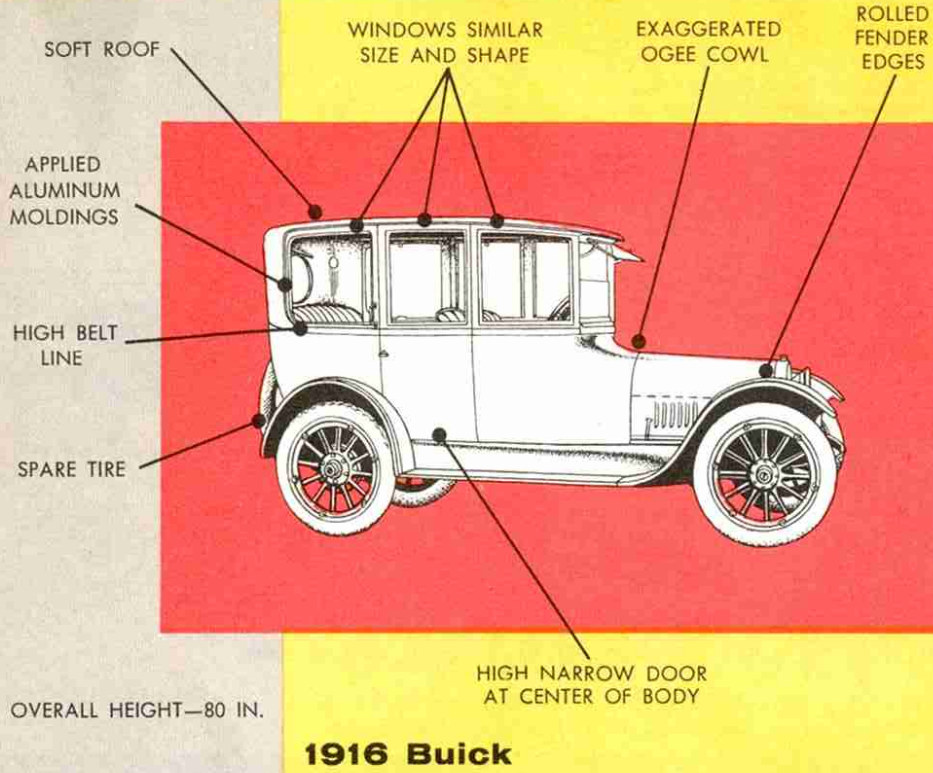

1916 Buick

The Beginning of the Closed Sedan

Up to 1915, most cars had open touring bodies, although a number of closed coupes and limousines had been offered to wealthy patrons as early as 1900. As better roads gradually became available and cars became more reliable, the driving season grew longer. There was a need for better

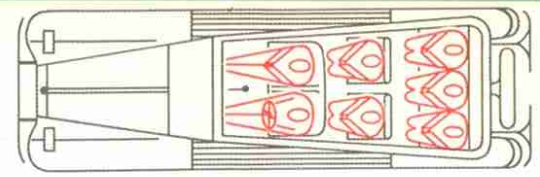

protection than side curtains afforded during cold and rainy weather.

In building a closed sedan, designers were forced to deviate from the lines of the touring car. For one thing, the prevailing ideas of head room dictated that a person should be able to stand almost erect in the interior. And since entrance ways were quite narrow by today's standards, a high door was needed for ready access. These limitations had a powerful influence on the shape of the closed sedan, establishing the overall height at 80 inches or more. The touring car belt line, now attractively on a level with the hood line, had to be raised considerably and the sweep of the "ogee" cowl was increased.

At first, access to both front and rear seats was through a single pair of doors located at the middle of the body. Almost immediately the advantage and convenience of locating the doors beside the seats became apparent and most manufacturers adopted this practice.

All car bodies of the period were wedge shaped, following the frame beneath which was tapered to clear the front wheels. Because of this shape the narrow front seats could accommodate only two people. However, seats for seven people were provided in some models by the addition of two folding auxiliary seats.

Although from a purely aesthetic standpoint appearance had been sacrificed, the proud owners of the enclosed sedans were able to travel many miles in inclement weather in comparative comfort.

Soft roofs, made of imitation leather stretched over a slatted foundation, soon became standard on low and medium priced cars. On expensive luxury models, aluminum roofs were often used.

1906 Reo, a chauffeur-driven landaulet with a collapsible rear quarter. The proportions of the door were typical of these early coach bodies.

1908 Cadillac. The first American gasoline enclosed car to be produced in quantity. Recipient of the English Dewar Trophy as the first car to achieve interchangeability through standardization of parts.

1912 Cole Limousine. The curved roof line, beautiful finish, carriage lamps, and window curtains contributed to the elegance of this car.

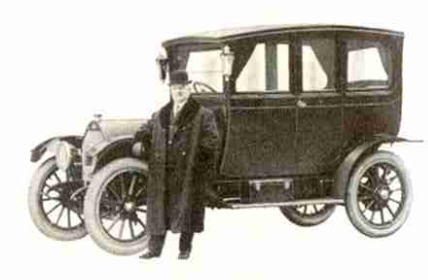
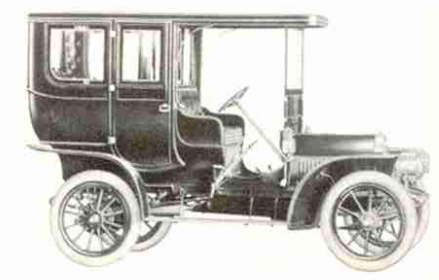
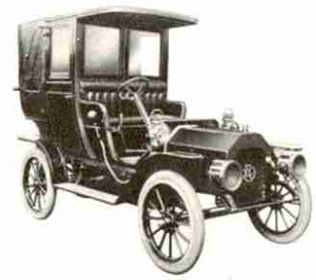
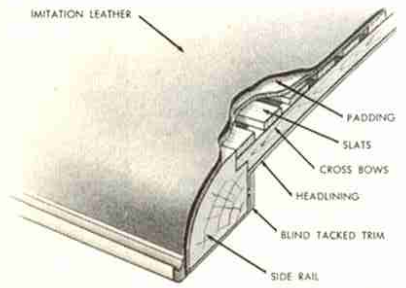

PREDECESSOR OF CANTILEVER TOP (NO VISIBLE SUPPORTS)

SEVEN PASSENGER TOURING

FLUSH COWL

HOOD MUCH HIGHER

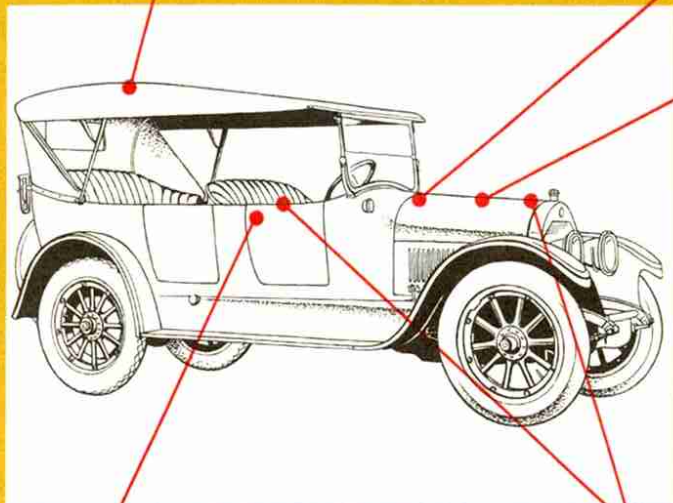

NO DOOR HANDLE

BELT LINE AND HOOD IN LINE

1919 Cadillac

1919 - 1922

Flush Cowl Replaces 'Ogee'

Following World War I, attention was centered on the "ogee" cowl, veteran of many years on all makes of cars. It was recognized that the classic relationship between low hood and high, wide body left something to be desired. Why not raise the hood line high enough to make it a continuation of the belt line? At the same time the width of the hood could be increased to match the width of the body. From a design standpoint the body and hood took another step toward becoming one complete integrated unit, instead of two separate objects joined together.

With this initial change, the touring car and sports car began to achieve the low-slung, racy look that was to be

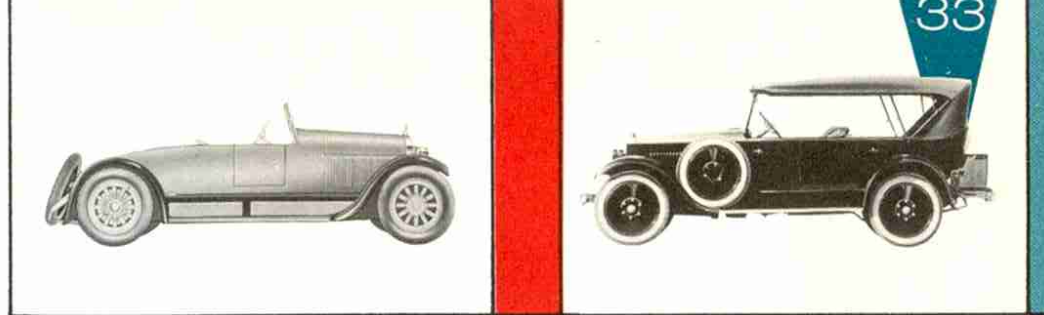

1922 Jordan Playboy. One of the outstanding sports cars of the twenties, subject of the famous ad, "Some Where West of Laramie, there's a girl . . . who loves the cross of the wild and the tame."

1922 Studebaker. The hood raised above the belt line, the bevel edged belt line and the slanted windshield were later developments of the period. Note the early use of solid steel disc wheels.

characteristic of them for the next decade. Along with the fabulous flappers, such good looking cars as the Stutz "Bearcat," Mercer "Raceabout" and the Jordan "Playboy" were part and parcel of the spirit of the "Roaring Twenties."

1923 - 1926

End of an Era

By the mid-twenties, the automobile was within reach of almost every American who wanted one. The demand was so great that automobile manufacturing was now one of the nation's greatest industries.

In the process of feeding the country's insatiable appetite for automobiles, the industry had been completely absorbed in expanding facilities, perfecting mass production techniques, and developing more powerful, more reliable products.

With this in mind, it is understandable that "aesthetic" appearance of the automobile was of secondary importance to the engineers and production experts who headed the individual concerns. These men believed that it was engineering improvements that sold cars, not looks. Hadn't they seen the self-starter, demountable rims, four-wheel brakes, high-compression (by their standards) engines, etc. sell thousands of cars?

Only in the custom shops did style-minded designers have the opportunity to control the appearance of all the elements that made up the exterior of the car. These small shops were forerunners of the modern styling departments.



INCREASED ROOF CROWN

VISOR

CHROMIUM PLATED TRIM

DRUM SHAPED HEADLIGHTS

STRIPING

TRUNK

DOUBLE-BAR BUMPERS

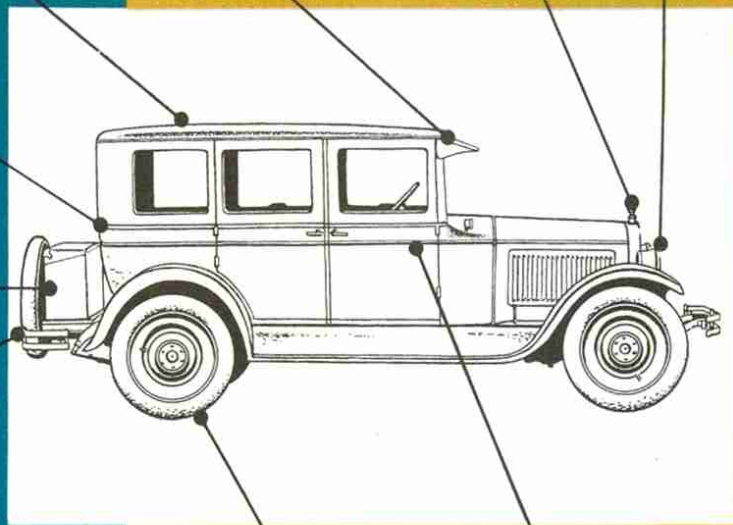

BALLOON TIRES

SECOND BELT MOLDING

LOWER SILHOUETTE
72½ INCHES HIGH

1926 Oldsmobile

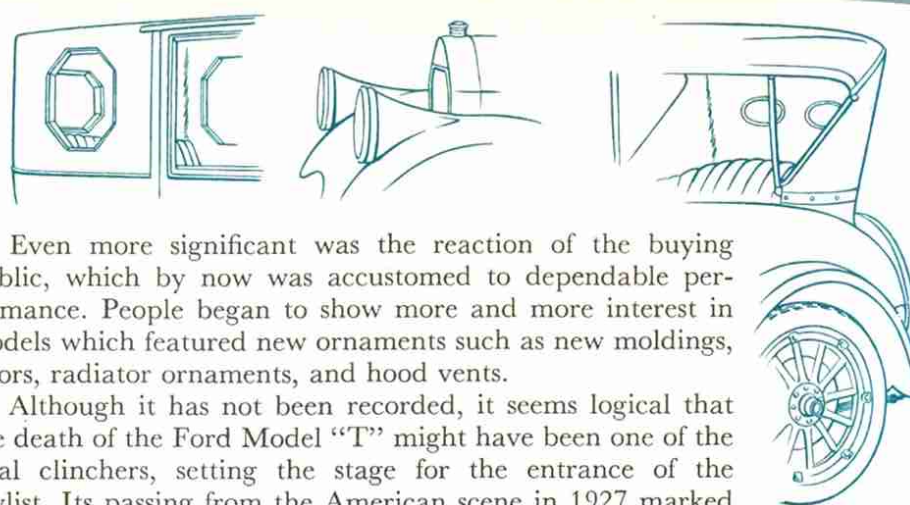

Even more significant was the reaction of the buying public, which by now was accustomed to dependable performance. People began to show more and more interest in models which featured new ornaments such as new moldings, visors, radiator ornaments, and hood vents.

Although it has not been recorded, it seems logical that the death of the Ford Model "T" might have been one of the final clinchers, setting the stage for the entrance of the Stylist. Its passing from the American scene in 1927 marked the end of an era in which one basic production model could be carried in production indefinitely.

horizontal belt line extended

By 1926 some progress had been made in lowering the silhouette of the automobile. Early standards of head room had been relaxed and seats had been lowered. Springs were now attached under the axle and smaller wheels with balloon tires were in use. But there were still fixed ideas about frame construction and level floors which limited further efforts to reduce the overall height and lower the belt line. However, instead of the 80-inch silhouette that was typical of pre-war cars, 70 to 73 inches was now usual practice.

About this time, a change in the horizontal belt molding was introduced. The new molding was located about 3 inches below the window molding and ran on a straight line all the way to the radiator.

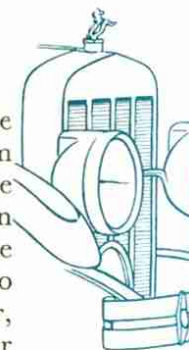

For some time—ever since World War I, in fact—there had been indications that the existing production cars, well engineered and reliable products though they were, weren't the ultimate answer. Art and style conscious critics began to complain about the appearance of the automobile, pointing out that it hadn't changed appreciably in ten years.

1925 Nash. Disc wheels, rear quarter panel with Landau joint, drum shaped headlights, and individual aluminum kick pads were features of this car.

1924 Buick. Fine hand-painted stripes were standard body decorations. The fabric roof extends all the way to the drip molding at the sides but at rear meets a metal panel called a "bald head." Two spare tires offered a sporty touch.

1924 Chrysler. First car to feature a second horizontal belt molding. Note characteristic radiator cap and rounded radiator shell. The window shades were very popular.

1926 Wills Sainte Claire featured aluminum body panels and fine construction at a time when hand craftsmanship was valued. It was considered one of the most beautiful cars of the day.

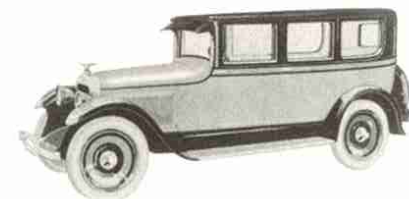
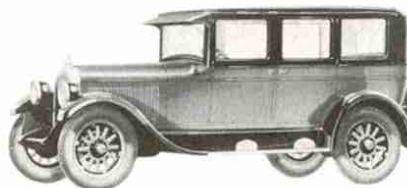
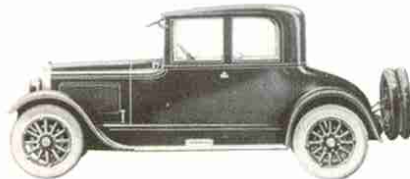

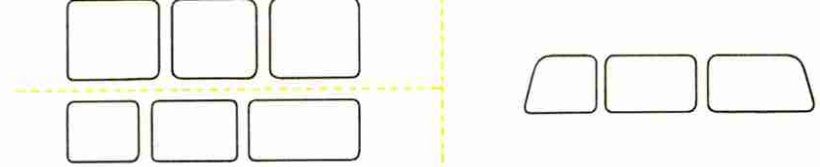
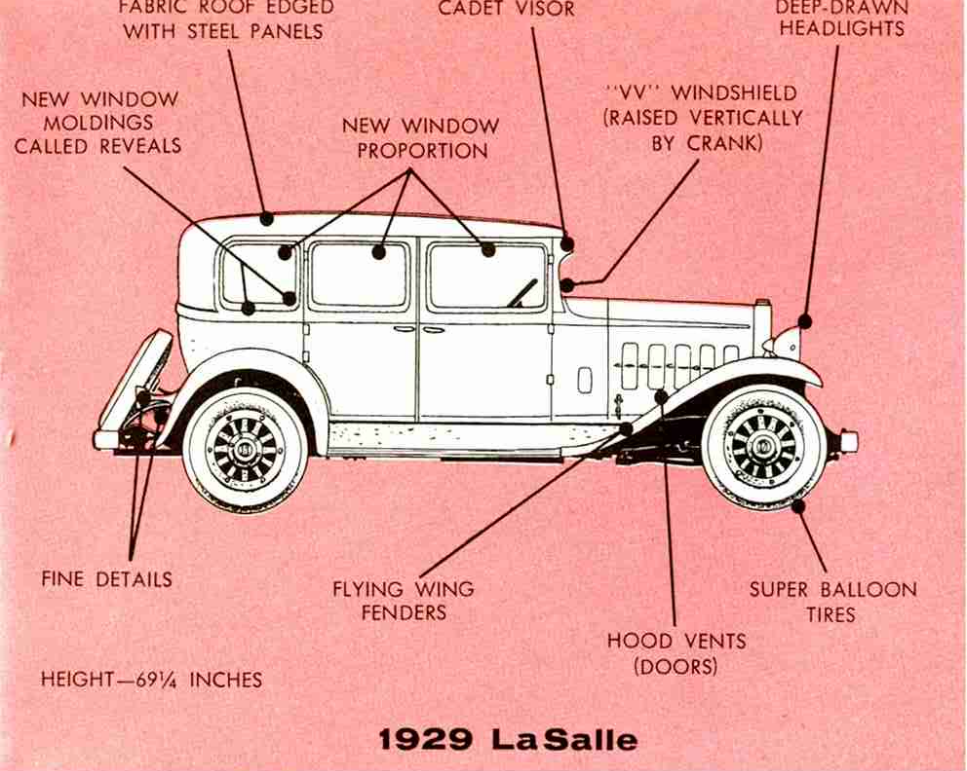

automobiles. With each success came new prestige for their profession.

Their job was to work with body engineers to improve the appearance of the automobile and all its components, giving attention for the first time to eye appeal. They were concerned with better proportion, more pleasing line, and a more harmonious blending of the components.

The infant styling departments soon found that black-board drawings, blueprints and fancy renderings couldn't always be trusted. For one thing, what looked good in two-dimensional form often developed a weakness when produced in a handmade three-dimensional pilot model. Also, they found that new ideas were difficult to sell in two-dimensional form, particularly in meetings with production men, engineers and management representatives when many problems in addition to styling were considered.

With this in mind, the Stylists began to convert likely looking drawings into full size clay models, exact likenesses of the body shell they proposed building. With plastic clay as the modeling medium, they were able to perfect their ideas: making alterations, correcting optical illusions and aligning highlights. See p. 55 for a picture story of this process at work on a modern dream car.

1927 - 1932

Enter the Stylist

The year 1927 marks the beginning of modern automobile styling as we know it today. At first it was a modest activity. Stylists had no authority, only the power to create new ideas —until it was shown conclusively that these ideas would sell

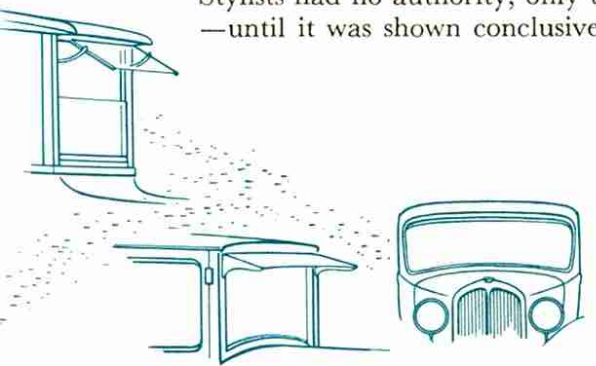

the stylists' law

These men took a long look at the automobile of 1926 and began to apply some of the farsighted beliefs that eventually

1927 LaSalle. One of the first production cars in the United States to be completely designed by a Stylist. Its success gave the styling profession a welcome boost.

1932 Pontiac. Wire wheels, curved windshield header and fixed windshield were later developments of the period. Indian head on radiator cap was Pontiac trademark.

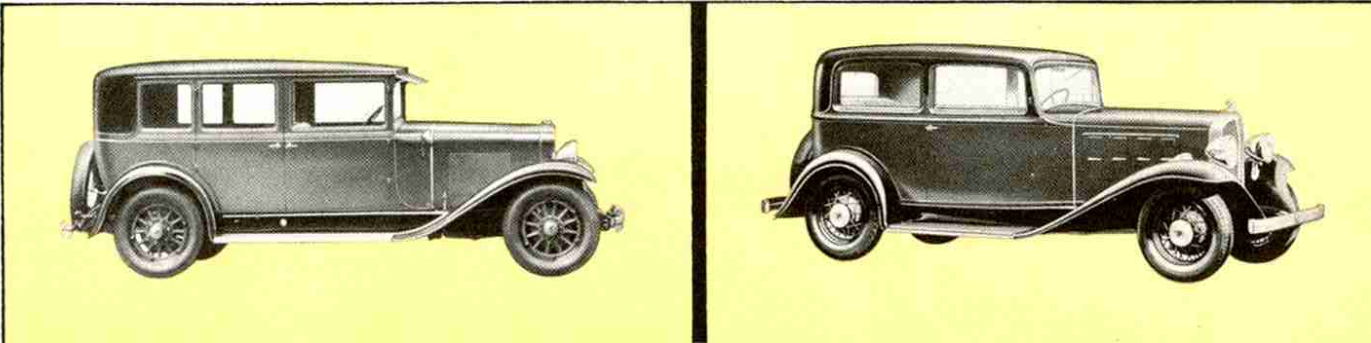

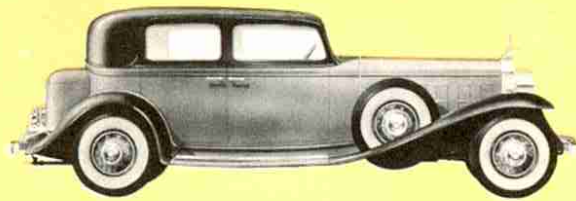

1932 Cadillac. An integral trunk had been included; and "flying wing" fenders had reached the ultimate in beauty. Dual tail lights and chrome plated trunk rack were important styling features.

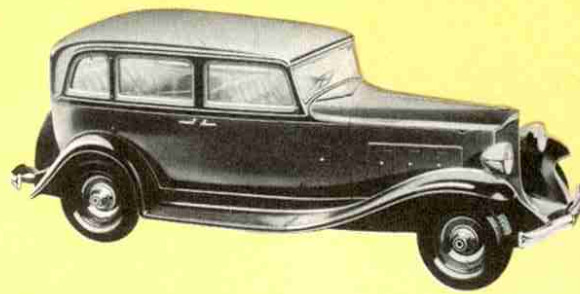

1932 Packard. The notched hood, long a Packard trademark was fronted by a V-shaped grille which juttied out at the lower edge. It was one of the early departures from the flat vertical core.

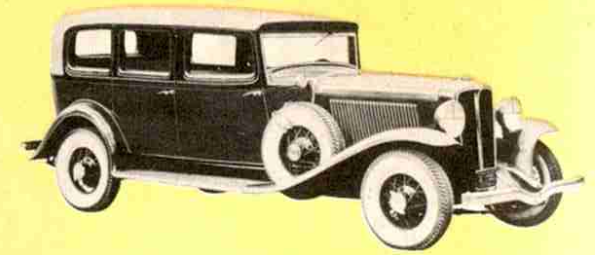

1932 Auburn. This car featured a light colored fabric roof covering that reached to the drip molding. The fender wells were quite popular. Large diameter lamps were used on some expensive models.

led to drastic changes in body design. In their opinions, the vertical, boxy lines of the current automobiles left much to be desired. They reasoned that an automobile is a thing of motion. Its lines, like those of creatures of motion in nature, should reveal this purpose. Therefore long, gently curving horizontal lines suggesting speed and power should be emphasized in the automobile. Vertical lines, suggesting immobility, should be shortened, and square corners rounded off.

That explains in part why the true Stylist from the very beginning has been in favor of lowering the car. Unable at first to accomplish this physically, the Stylist suggested changes which made the automobile *look* lower and longer almost immediately.

windows more than openings are

Take windows, for example. Until this time all side windows in four-door sedans were the same width and the same proportion. The Stylists proposed lengthening the front two and shortening the third window. This simple change in proportion (see p. 35) gives the impression of greater length to the group, although both overall dimensions are exactly the same. To increase this impression, the top window line was lowered and the roof crowned. This new concept of window design, seen here in its infancy, was to produce later (1935) a two-window sedan with a blind rear quarter and finally the modern sedan with the curved glass back window.

fenders more than mudguards are

For the first time in the history of the automobile, attention was given to the appearance of the fender. Originally fenders were simply flat mudguards. Next came rolled fenders with turned over edges and, more recently, one-piece affairs, stamped in dies. Now with more ductile steels made available by the metallurgist, the Stylist took advantage of the more flexible material by designing the graceful "flying wing" fenders. The attractive, deep crown and the sweeping curve of these fenders contributed to the longer, lower look the Stylists had in mind. Flying wing fenders gave the automobile the appearance of poise, ready for flight.

1933 - 1934

No Longer A Coach—It's All Automobile Now

The depression years, 1933 and 1934, marked the introduction of a number of styling features which if adopted individually would have done little to improve the appearance of the automobile. When molded together according to a plan conceived in the imaginative minds of the Stylists, however, these features completed the evolution of the body from a coach to an automobile.

Included were: V-shaped radiator, slanted windshield,

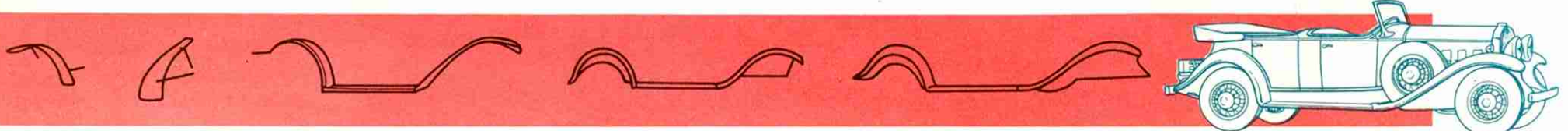
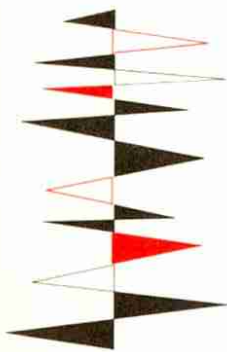

HEIGHT—68 INCHES

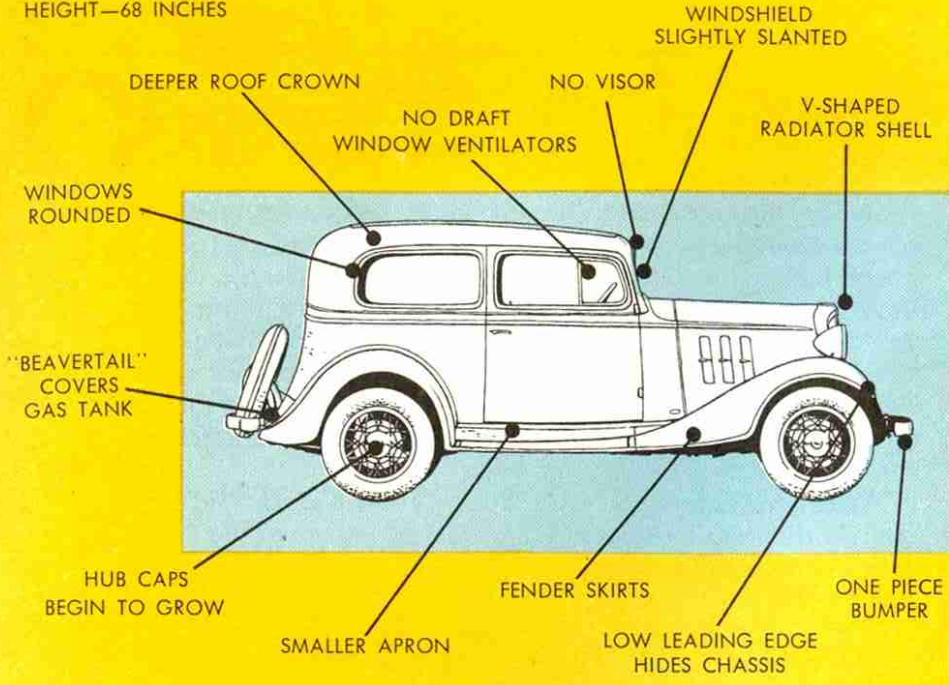

1933 Chevrolet

fender skirts, deep roof crown, body extension in rear, and front fenders with a low leading edge. These design elements did several important things for the appearance of the automobile. One was to cover such unsightly chassis parts as gas tank, under-fender and springs, which had detracted from car appearance for more than thirty years. Stylists had recognized that there was no valid reason for continuing them in plain view.

1932 Graham-Paige. First use of fender skirts on a production automobile. Note absence of radiator core and cap.

1933 Oldsmobile. The "flying wing" front fender had been replaced by a fuller design. Here too was a new idea in wheels, a replacement for artillery and disc types. Twin tail lights had become standard.

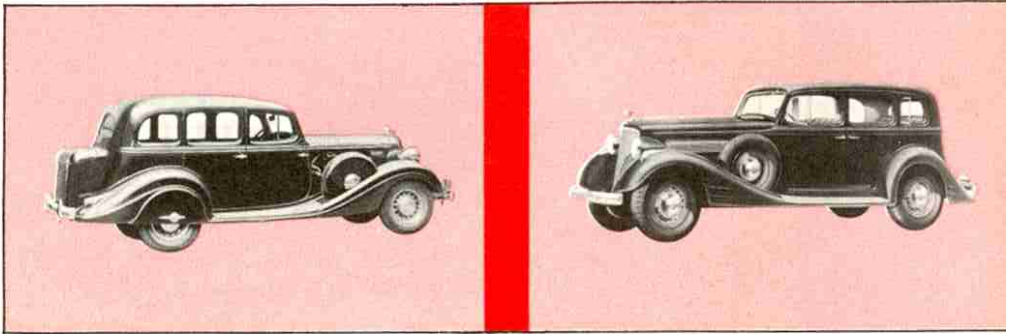
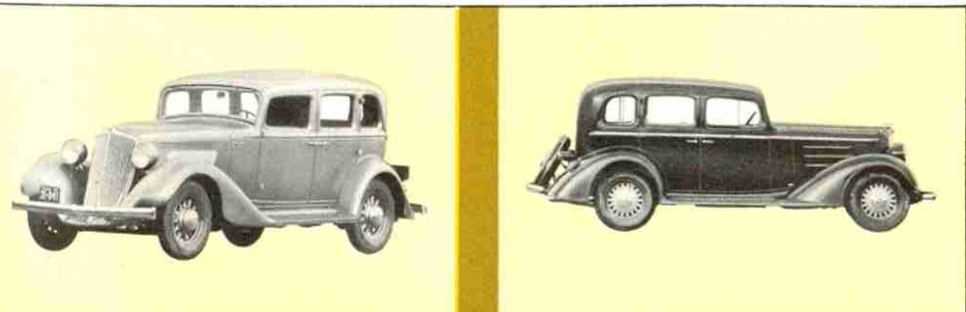

1934 Hudson. Built-in trunk with separate tire wells in the front fenders preceded the tire mount in trunk. Rear wheel covers represented early attempt at streamlining. All doors hinge at rear.

1933 Pontiac. The hood was extended back to windshield and covered cowl. Note that the carriage lights had become parking lights and were located in the fenders. Horizontal louvers were characteristic.

A second effect of these innovations was a more finished, more integrated look, a logical step in the evolution of the automobile and what we recognize now as the beginning of streamlining (see p. 39). Here was another attempt by the Stylists to replace straight vertical lines with sloping or curved lines.

1935 - 1937

The Body Moves Forward and Downward

For some time, styling experts, as well as progressive engineers in the industry, had been proposing a basic change in the relation between body and chassis. Remember that after all these years, rear seats were still high over the rear axles, floors were still flat, and radiators were still in line with the front axles.

What the Stylists wanted was to move the passenger compartment forward away from the restrictions of the rear axle.

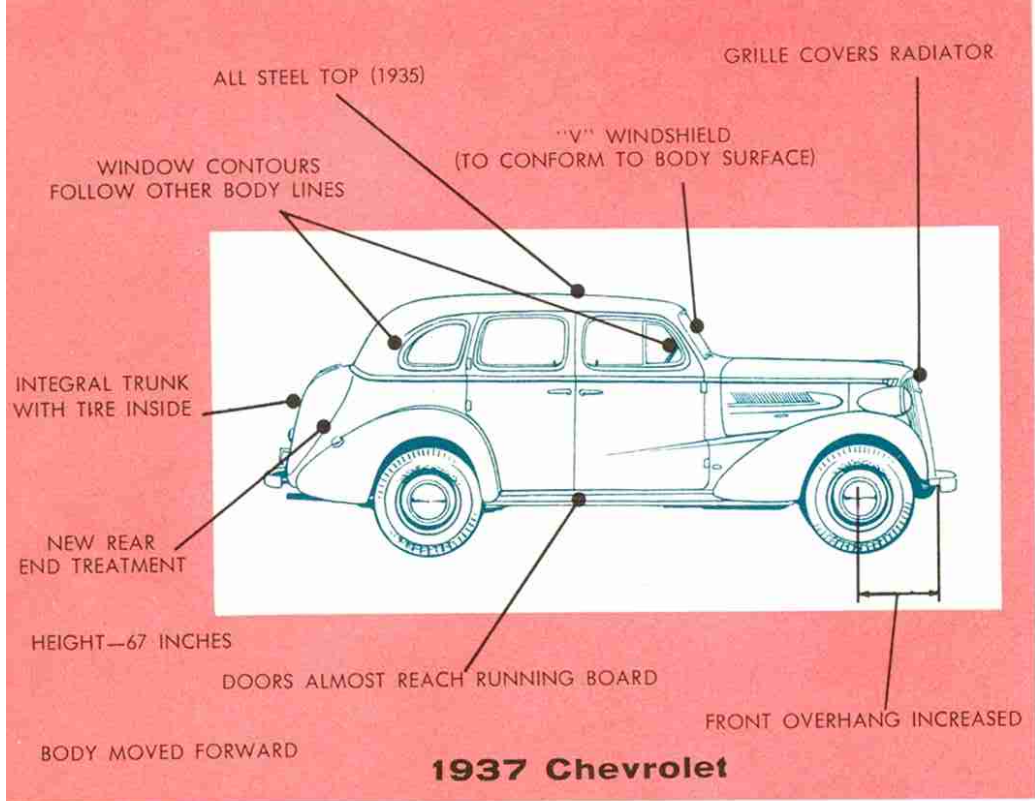

How the hypoid gear and pinion helped lower the propeller shaft, a limiting factor in locating the floor level.

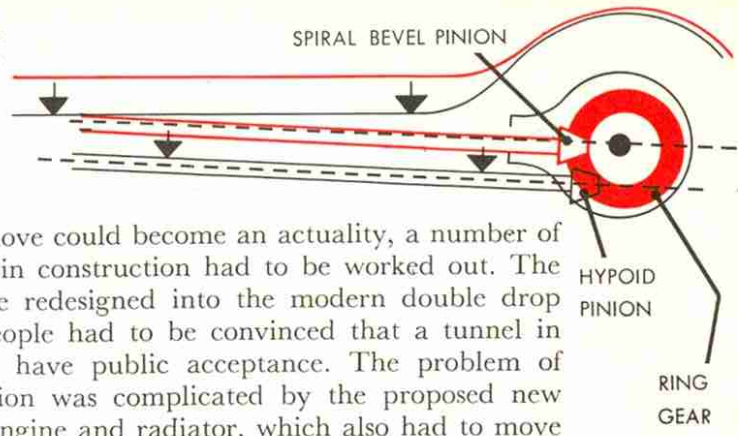

Before this move could become an actuality, a number of related changes in construction had to be worked out. The frame had to be redesigned into the modern double drop frame. Many people had to be convinced that a tunnel in the floor would have public acceptance. The problem of weight distribution was complicated by the proposed new location of the engine and radiator, which also had to move forward because of their fixed relationship with the passenger compartment.

When introduced in 1935 the new automobile had an entirely different look. The doors reached almost to the running board and the apron had practically disappeared, as a result of the lower frame.

The back of the car began to take on a new purpose as the idea of covering the gas tank was expanded. The amount of rear overhang was further increased either by giving a slope to the back or by adding an integral trunk. The result was a storage space within the body big enough to house the spare tire. This marks the first time in the history of the automobile that the spare tire was hidden from view.

At the front the silhouette also changed radically as a result of moving the engine and radiator forward on the chassis. The radiator core disappeared beneath the hood. In place of the vertical shell, a new grille joined the hood and fenders.

The idea of a grille had started several years before with a chrome plated screen installed in front of the radiator core, first as protection against flying stones and later as a decorative measure.

The body could then be lowered by 2½ inches or more, a wonderfully desirable change, from the standpoint of appearance, in the opinion of the Stylists.

Equally important from the customers' standpoint was improved riding comfort in the rear seat. Suspended between the axles, passengers would no longer feel the full impact of road shocks. Among the engineering advocates of this change were the champions of a lower center of gravity who wanted to improve cornering or turning ability.

Moving the passenger compartment and engine forward permitted the Stylists to develop a lower silhouette.

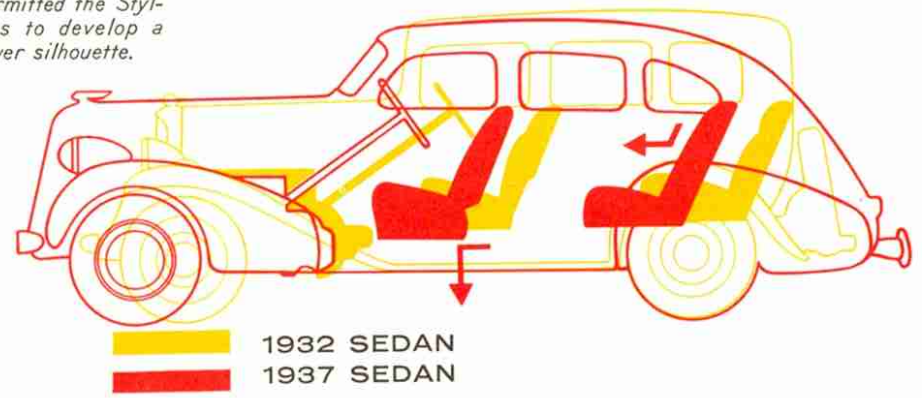

1936 Pontiac. The stainless steel stripes or "silver streaks" on hood and deck lid are excellent examples of design features used to stamp specific models with individuality.

1934 Air Flow DeSoto. A product of the school of design that believed in one interpretation of the streamline theory.





Beginnings of the modern trunk.



the all-steel top erases an old problem

All of a sudden the Stylists, particularly the tall ones, realized cars had become so low that the roof top was partially visible. What the Stylists saw of the roof they didn't like. Soft fabric tops, dull, dirty looking, and subject to deterioration, had to go.

Realizing that a smooth, molding free, all-steel top offered a solution to this problem, the Stylists began a program of persuasion and argument in its favor.

Old time body men feared "drumming," a vibration-caused noise that cropped up in earlier un-crowned steel tops. To them it also meant the end of the wood body, then considered stronger, quieter and of higher quality. More progressive body men accepted the challenge and came up with a design that was not only more durable but stronger and safer.

The technological advance that made the all-steel or turret top possible was the availability of wider steel strip—110 inches, instead of the conventional 72 inches. In a large sense, this advance was hastened by the Stylist who created the terrific demand necessary to justify such a large investment by the steel industries.

four-window sedan with blind rear quarter

In 1935, there appeared a new body style that was con-

Section view of soft top showing method of joining metal panel and imitation leather.

1935 Cadillac. It featured two windows on a side and a blind rear quarter and was one of the first cars in the industry to have a one-piece steel top. Note how far forward the body had moved in this close coupled sedan.

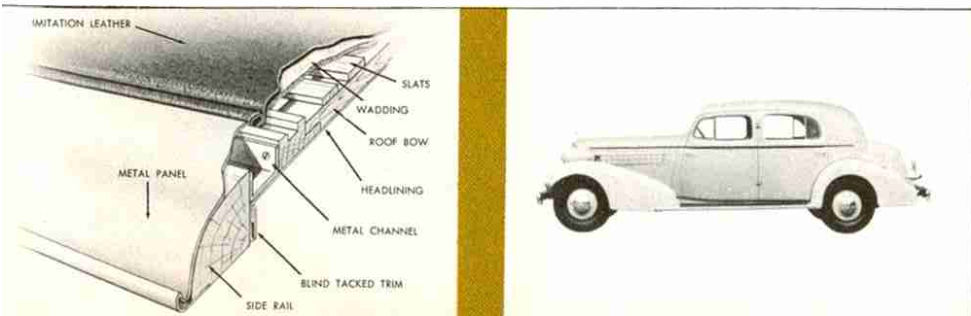

sidered by the Stylists themselves as the most significant body change in years. It was a four-door sedan with only two windows on a side instead of the conventional three.

In place of the third window was a blind rear quarter. The new proportions of the superstructure again made the automobile appear longer and lower.

1938 – 1942

The Influence of Streamlining

During the middle thirties there started a trend toward streamlining the automobile. Technically speaking, streamlining is designing for low air resistance. This was the age of streamlining, the result of wide publicity in connection with airplanes. Everything—furniture, toys, tools, boats, etc.—was streamlined, whether it needed it or not. As a result the word now is applied to almost any shape on which the corners and sharp edges are rounded off.

Many people, in describing what cars of the future would look like, predicted an evolution into a tear drop or egg form because these were known to be the most perfect streamline shapes. Among the automobile Stylists were supporters of this general idea. More, however, favored a different approach—that of a longer, lower silhouette which would give the impression of speed without certain drawbacks inherent in a streamline shape.

A list of the design elements which reflected the interest in streamlining would include: horizontal grille; streamlined or fast back; gradual disappearance of running boards, brought about by a lower, wider body; and front fenders which extended toward the rear.

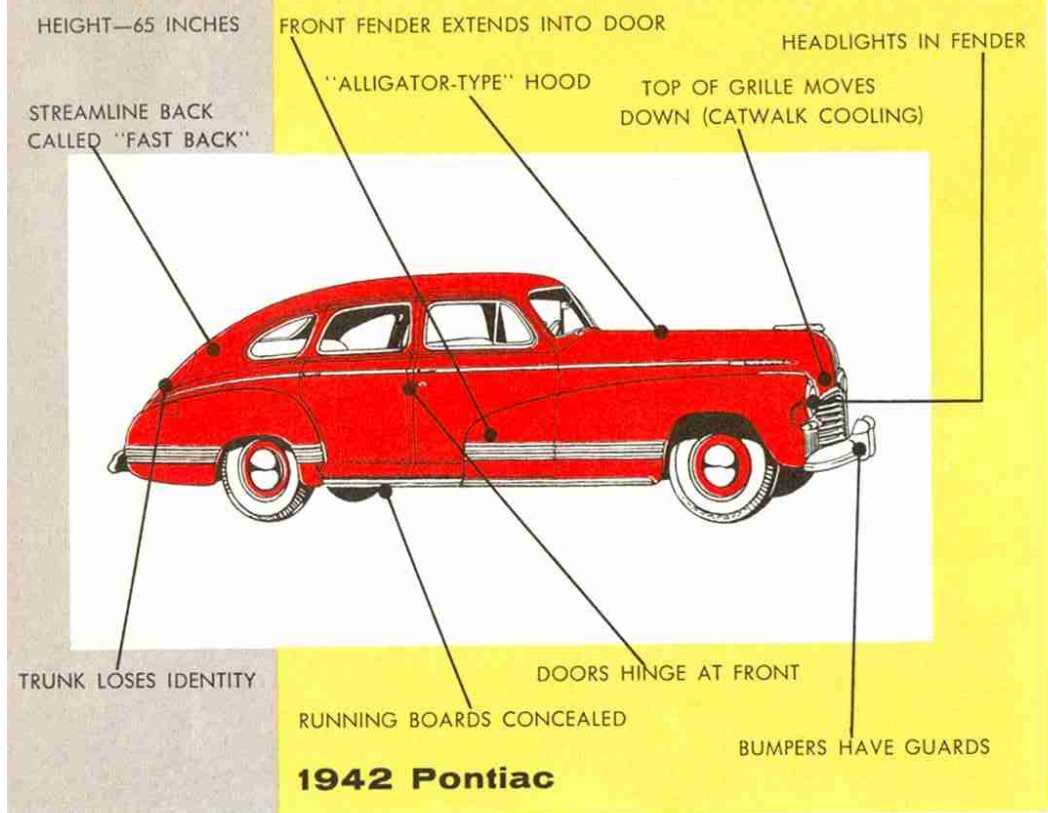

1942 Pontiac

new look for front ends

Although car owners of the late twenties had lovingly referred to the "fleur-de-lis-like" appearance of the front ends, this view leaves much to be desired aesthetically. Realizing this, the Stylists in 1937 planned drastic changes for the flared fender, just introduced in 1932, and the vertical grille.

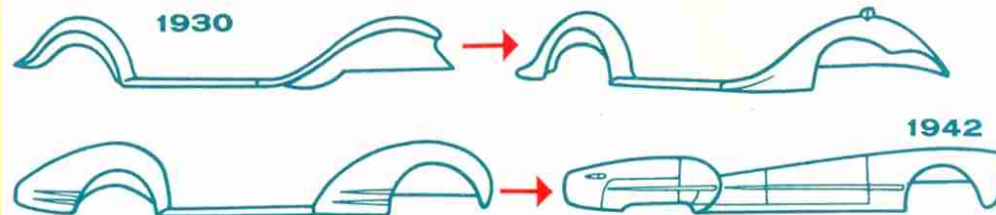

First they gradually raised the gutter between fender and hood (called the cat walk) until it reached the level of the fender top.

Then slowly, a little at a time, they reduced the height of the grille, extending the hood line forward and downward. At the same time the lower portion of the grille was gradually widened. By 1940 the grille had become a horizontal element which extended from fender to fender.

the body grows wider

Tied in closely with the new front end treatment was a brand new body shell. Designed to be even lower, it was also



Rear end evolution.

1938 Buick. The roof had a more pronounced crown and the windows were contoured with the posts. Windshield and rear windows were split to conform to body surface (curved glass was not available).

1938 Cadillac. The first Cadillac "60" special featured a distinctive door with chrome upper frames. It also had the first extended trunk and the lowest overall height of any production car at that time (65").

1941 Lincoln Continental. Distinguished by excellent proportions, this car featured a long, low silhouette and an extra long hood. Note that the running board and door handles had disappeared and the continental tire mount was revived.

1939 Packard. The familiar radiator shape was continued, but modified to suit the new body style. Tire wells were still possible until the forward movement of the body eliminated this space.

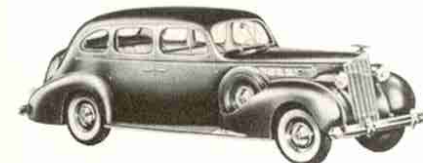

1946 – 1953

Post-War Designs Offer New Concepts

much wider than ever before. Hip room in the front seat was from 58 to 62 inches—enough room for three people. Instead of following the frame as in the past, the new body paralleled the running boards, extending out over them.

As this trend continued, the question of retaining the running boards was raised. The floor level and seats were low enough, the doors wide enough to permit entry without a running board. But the public was accustomed to running boards, and the Stylists, knowing from long experience that automobile buyers accept change very slowly, moved ahead with caution. First a much narrower running board was designed; then it was covered by an extension of the door; and finally it disappeared entirely to be replaced by a narrow sill.

With the end of World War II, the American people clamored for new cars. True, the pre-war cars had lasted better than pessimists had predicted—but having looked at them for five long years, everyone was just plain tired of them. The public waited eagerly while the automobile industry converted from war production to the business of making new cars.

It was during the time it took to retool, that the average citizen became aware that making a model change in a mass produced commodity had become a long expensive process. Even after an actual design had been completed, a period of 1½ to 2 years was needed to make dies, build special tools, contract for sub-assemblies, and make the necessary alterations to the production lines.

To cut down on the waiting period, most automobile manufacturers decided to revamp 1941 and early 1942 models. As a result, the 1946 production cars were quite similar to pre-war models.

Within two years, however, teams of Stylists, engineers and production men had attacked the problem of design with new vigor and had come up with several new developments.

body and fenders merge

Until just before World War II, the side contour of the body had been unchanged for many years. Following the custom of the coach builders, the body above the belt line had been straight up and down, and below the belt line had curved inward toward the apron. A wide shouldered look, it might be called, with the widest section or shoulder at the belt line.

The Stylist began to change this concept of body design about the same time the running boards disappeared. The

The evolution of design in the front of the automobile—1927 to 1942.

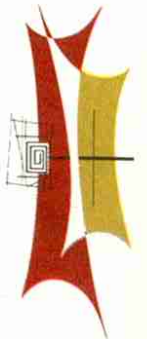
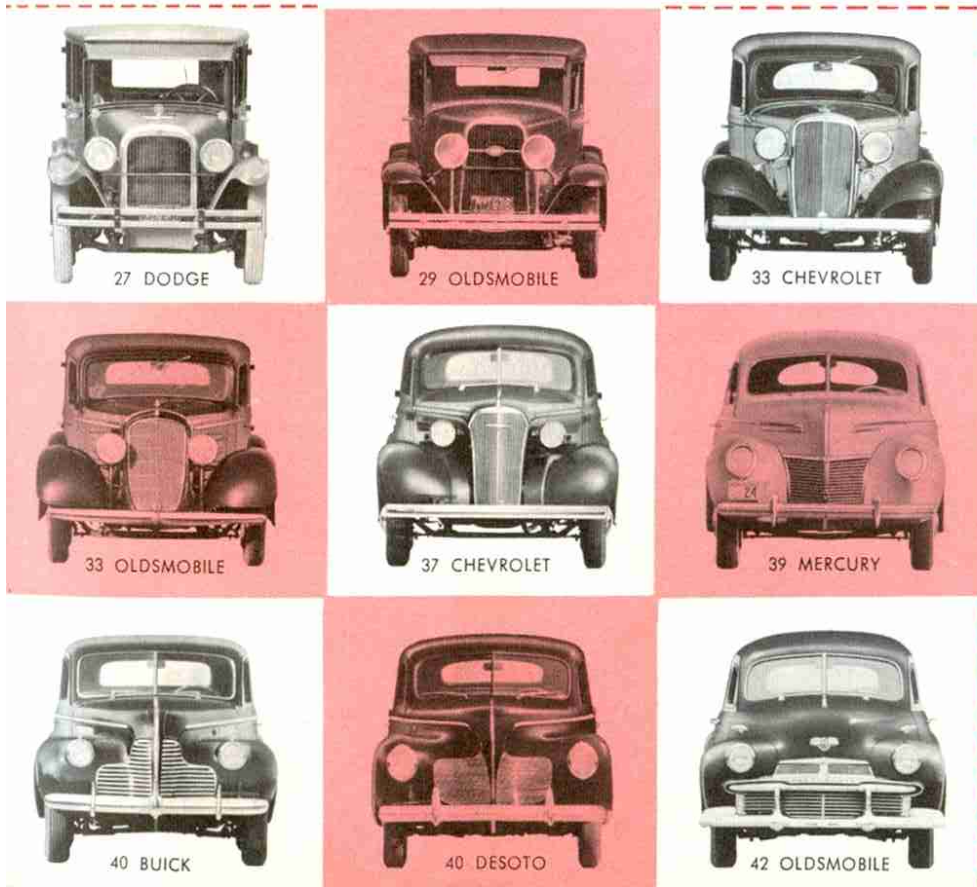

HEIGHT—63 INCHES

CURVED REAR WINDOW

ONLY FOUR SIDE WINDOWS

CURVED WINDSHIELD

INCREASED USE OF BRIGHT METAL

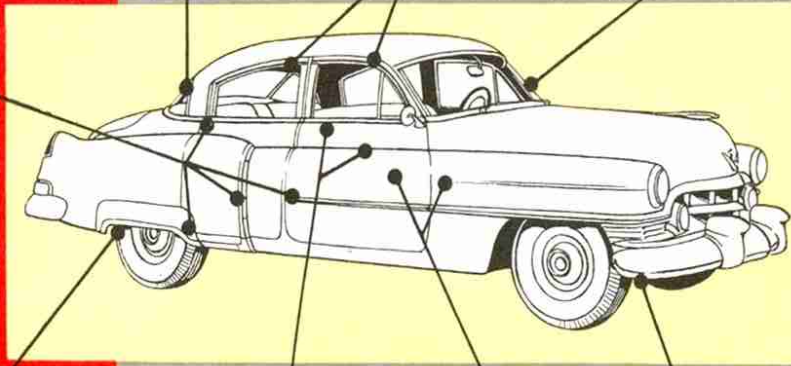

FENDER OPENINGS RESHAPED

FENDER LINE AT OR NEAR BELT LINE

FENDER AND DOOR FLUSH

WRAP-AROUND BUMPER

1950 Cadillac

body surfaces above the belt line were made to slope inward from belt line to drip molding. The amount of slope, called "tumble home" in the trade, was increased proportionately as the belt line moved outward. Below the belt line, the "turn under" curved outward and downward. The widest section of the car was now below the belt line.

As this trend continued in post-war cars, the door panels eventually merged with the fenders, marking another successful move in the direction of a more integrated design.

For a while, the top fender line and the belt line retained their own separate identities, but eventually the two approached each other. In the process, the fender line was raised and the belt line pushed outward. Now the curvature of the doors and both fender surfaces merged into one long graceful highlight which added greatly to the appearance of length. What pleased the Stylists was this: here was another giant step toward the integration of all the components into a complete unit. Inside there was more hip room and shoulder room as a result of the new location of the belt line.

curved glass windshields and back windows

Stylists, by nature, are given to experimenting with new ideas and developments, a tendency which sometimes presents a challenge to production experts.

Take window glass, for example. Although it was known in 1949 that sheet glass could be curved, no one had attempted this in an automobile. To the Stylist the idea of curved glass was worth the manufacturing and installation difficulties. In this he was backed by safety engineers and body men. Used in windshields and back windows, curved glass would increase visibility, promote safer operation, and allow new design possibilities. This single development, when adopted, changed the appearance of the entire automobile, and led to even more significant changes later on.

1947 Studebaker. First completely redesigned post-war car. The "peak" line of the front fender extended the length of the car. Side surfaces of front fender and door were flush.

1949 Ford. As door and fender surfaces merged the belt line moved out to a position immediately above the fender line highlight.

1949 Buick. First two door sedan in the industry that had no number two post was named "hard top convertible" by news writers, although its top was neither convertible nor harder than other closed cars.

1952 Oldsmobile. The extreme extension of the rear deck increased the length of the rear fender and produced a new style.



the two-door hard-top

Convertibles, with collapsible canvas tops, had always been popular, presumably because of the open-top feature. The Stylist came to realize that a surprising number of convertible owners seldom put their tops down, but continued to buy convertibles year after year. Perhaps, the Stylists reasoned, it was the lines of the car that appealed. Perhaps a two-door coupe without a center pillar—and hence a convertible look—would find favor with people who normally wouldn't buy a conventional convertible.

After considerable preliminary design, including a strengthening of the supporting pillars, the first version of the hard-top convertible was introduced by Buick in 1949. The absence of the center pillar plus the attractive lines of the new rear quarter panel contributed to a new look that was very popular. This led to the introduction by Buick and Oldsmobile in 1955 of a four-door hard-top.

1954–1956

Panoramic Windshield

One of the goals the automobile Stylists always keep in mind is the increased comfort and safety of the driver and passengers. They pre-judge all of their new ideas by asking the question, “How will this affect passenger comfort and safety?”

If the Stylists are convinced that a new design approach will improve one or the other of these two factors as well as add to beauty, they are likely to raise heaven and earth to

The first panoramic or wrap around windshield appeared on GM's experimental car, the LeSabre, developed by GM Styling in 1946 to 1950. Buick, Oldsmobile and Cadillac were first to make this feature available on their 1954 production models.

overcome any manufacturing difficulties that stand in the way.

Consider the panoramic windshield, for example. There's no doubt that it gives the driver increased visibility, a definite safety factor in the operation of an automobile and one that was becoming increasingly important as traffic density increased. It has equal appeal as a visual design element.

Before the panoramic windshield could be produced in quantity, many obstacles had to be overcome and the team of Stylist, production expert, and engineers went to work on them. Major stumbling blocks were: design of the windshield pillar which would now have a “dog leg” in it that presented a problem both from an expense and strength standpoint; and manufacture and installation of the big windshield itself. Incidental problems were storing and handling of the glass prior to assembly and designing a satisfactory weather seal for the “dog leg” in the front door.

One by one each of these problems was analyzed and

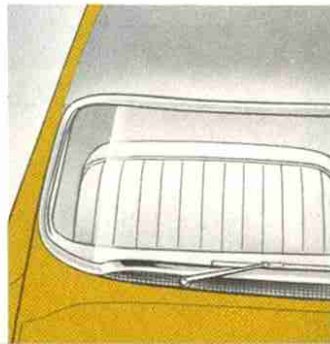
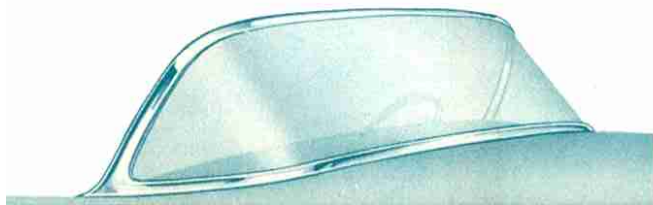
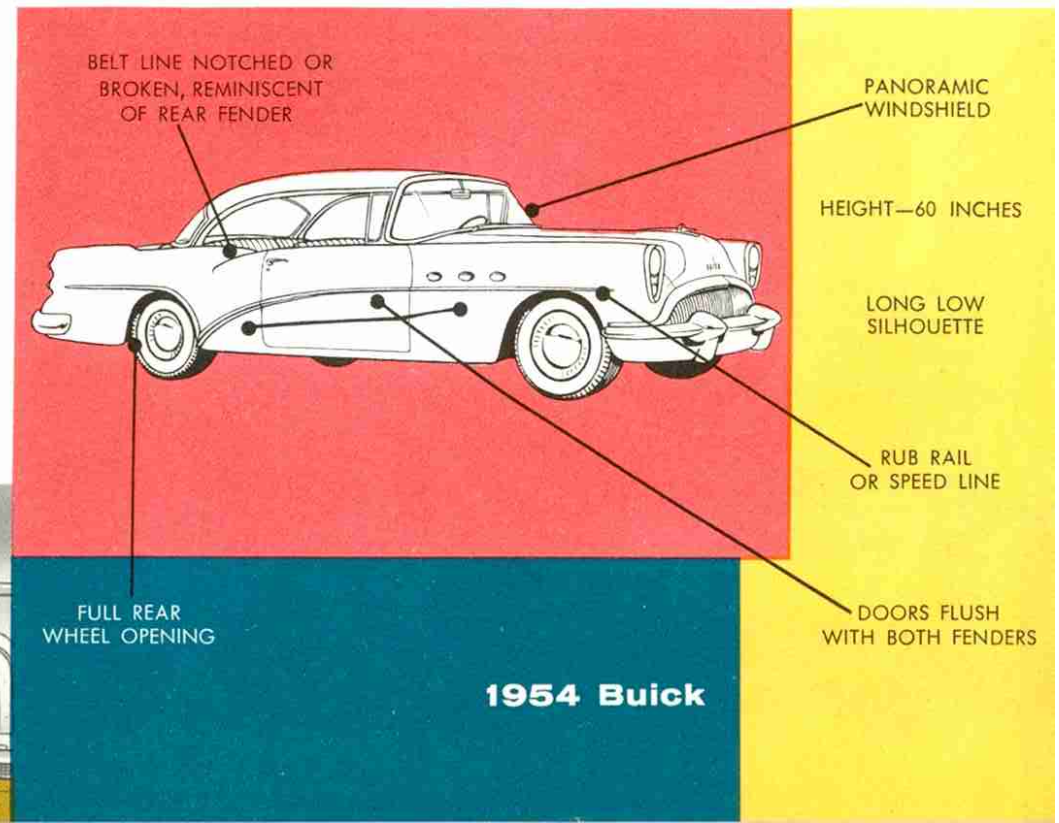

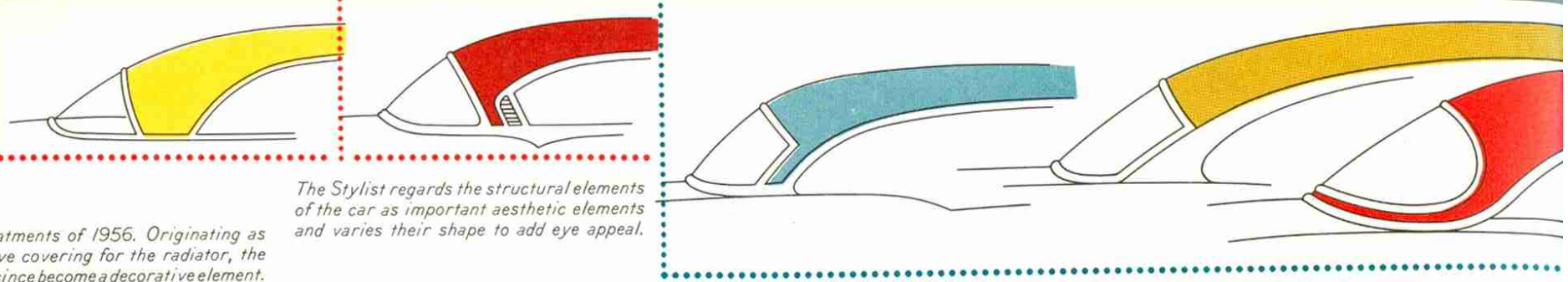

Grille treatments of 1956. Originating as a protective covering for the radiator, the grille has since become a decorative element.

The Stylist regards the structural elements of the car as important aesthetic elements and varies their shape to add eye appeal.

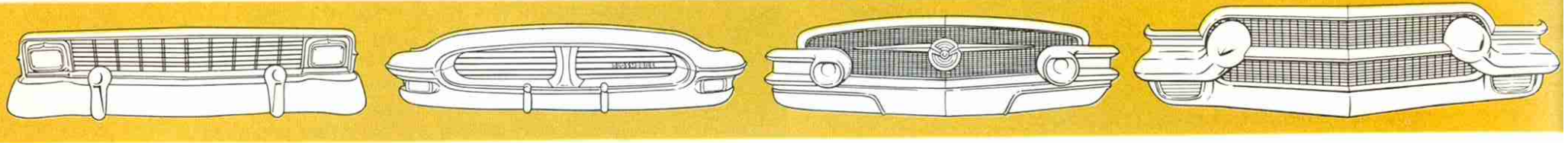

solved. The final decision to put the panoramic windshield into production was many years after the first sketching, designing, and discussion began.

still lower, longer, wider

In the years 1954 and 1955 the Stylist helped bring about a radical change in the over-all proportions of the automobile. The aim as always was to arrive at a lower silhouette. Yet it must be done without sacrificing space in the passenger compartments, engine compartment, trunk or without retreating from established standards of accessibility or visibility.

It is significant that the automobile was made lower on the

outside without sacrificing headroom on the inside. The reduction in overall height was the result of lowering the floor level and slightly reducing the height of the seats. Seats could now be lower, it was recognized, since less foot manipulation was required of the driver because of the availability of automatic devices. The fact that seats were closer to the ground and to the outer edge of the car made access easier. It was possible to sit down on the seat without first climbing into the car.

The development of compact V-eight engines and new pancake type air cleaners, products of engineering and research, helped lower the silhouette of the hood. In the rear, to maintain the roomy luggage space to which all Americans have become accustomed, the Stylist raised and lengthened the deck lid.

1955 Oldsmobile four-door hardtop. This body style was first introduced by Oldsmobile and Buick in 1955. A descendant of the two-door hardtop, it combined the convenience of a four-door sedan with the aesthetic appeal of a two-door hardtop. A powerful stub door post, hidden from view, replaced the conventional sedan number two post.

1956 Chevrolet station wagon. Car-length rub-rail and fender extensions at front and rear emphasized the long, low silhouette. Attractive textured grille, contoured fender openings and large window glass area were typical styling features. Side windows that wrap around the rear quarter were unusual.

1956 Pontiac four-door hardtop. A longer silhouette was obtained by increasing the rear overhang (first done in 1954). The effect of greater length was enhanced in 1956 by the addition of speedlines on the rear quarter panel: one was a tapered bulge which joined the visored taillight; the second was a sculptured horizontal chrome panel at the bottom. Dual chrome hood lines were repeated on the rear fenders.

1956 Buick convertible. Sloping door belt line meets raised section in rear quarter which marked the beginning of the rear fender. Repeating the sweep spear curve in the beltline produced a feeling of symmetry. The grille texture was a variation of an idea first introduced in 1955. Note full rear fender cut-out.



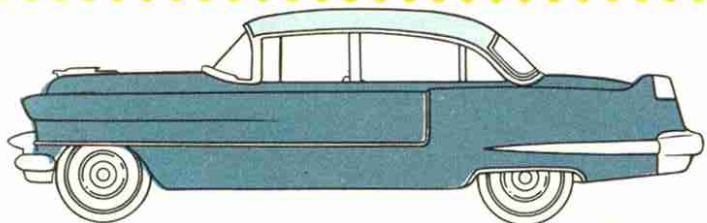
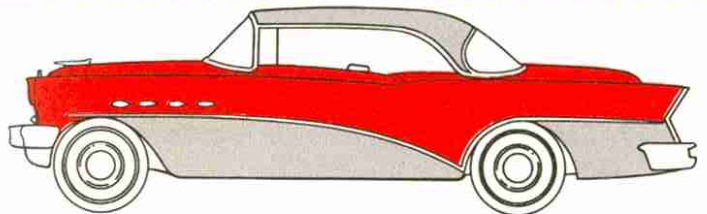
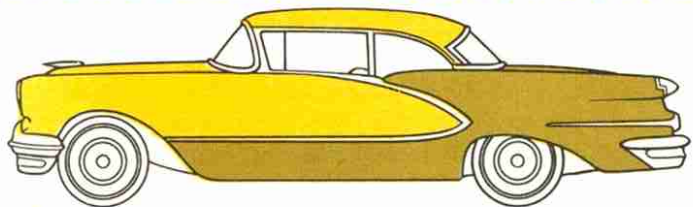
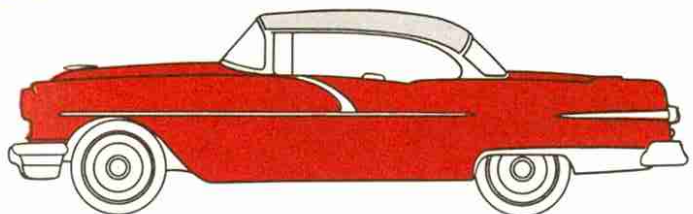
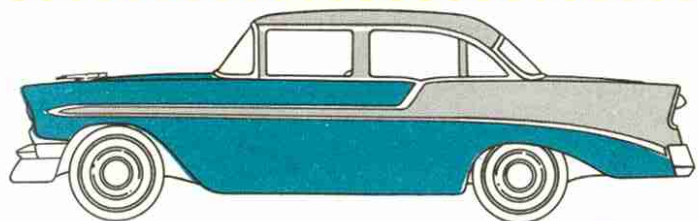

Cars of the period featured two-tone finishes and more bright metal. The use of bright metal has several important functions: (1) to accentuate form; (2) to separate colors; and (3) to provide protection against bumps for painted surfaces.

color outside and inside

For the first forty-five years of its existence, the automobile was quite somber in appearance. Black was by far the most popular color for exteriors. If you didn't want a black car you could have blue, green, maroon, but these, too, were on the dark side.

Inside, all fabrics and appointments were equally on the conservative side. Grey, black, and brown predominated.

It wasn't that automobile Stylists didn't recognize the value of color as a design element. It took time for paint and dye technology to reach its present degree of versatility. Then, too, public taste had long been accustomed to and approved of conservative colors. People have been slow to accept bright colors and light values.

Gradually, in the years following World War II, public tastes in color began to change. Many bright and beautiful colors began to appear. Undoubtedly their popularity was due in a large part to the influence of the women on car buying, who traditionally have more advanced taste in color than men.

Within a few years, the Stylist also had introduced color to the interior of the car, colors carefully matched and keyed to the exterior color scheme.

From this point on color had increasingly greater acceptance from the public. Brighter and brighter shades, two-tone and three-tone combinations became popular.

A second color is introduced to inside door panels and instrument panels. New configurations of instrument clusters and padded panel surfaces were features of the period.

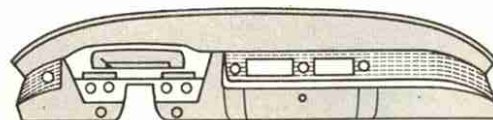
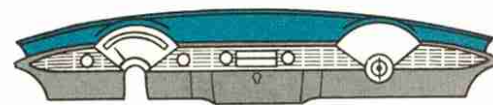
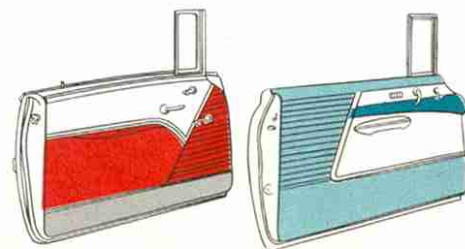

HEIGHT—56.4

TEXTURED METAL AND MOLDED PLASTIC INTERIOR

SPECIAL ROOF TREATMENT

DUAL HEADLIGHTS

MISSILE-THEMED SIDE MOLDINGS

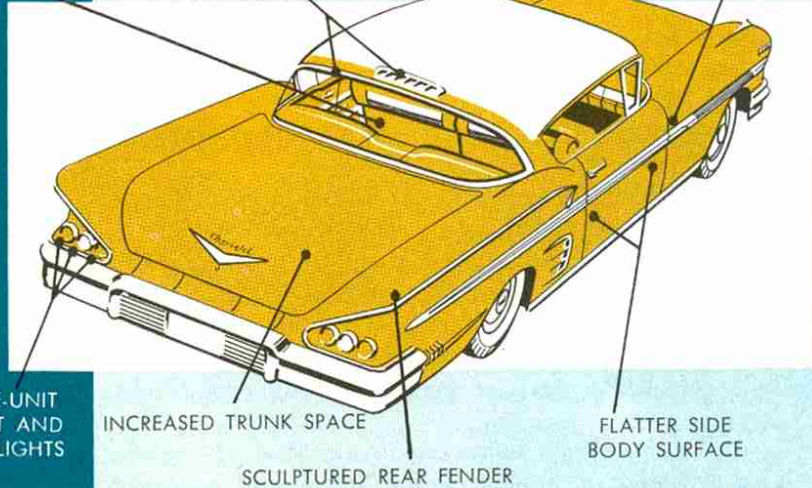

MULTIPLE-UNIT TAILLIGHT AND BACKUP LIGHTS

INCREASED TRUNK SPACE

SCULPTURED REAR FENDER

FLATTER SIDE BODY SURFACE

1958 Chevrolet Bel Air Impala

1957-1958

A New Look Coming and Going

Intense competition among the automobile manufacturers in 1957 and 1958 again focused attention on appearance design. There was a growing demand for greater yearly change in the appearance of new models even on the off years—in between major body changes. The trend to lower,

1958 Pontiac Bonneville Convertible. A new series introduced in 1958, the Bonneville's low height was emphasized by the missile-themed projectile and sheet metal shape on the rear quarter. Stainless steel rocker panels, wrap around bumpers and dual taillights and headlights added to the distinctive low appearance.

1958 Oldsmobile Fiesta Station Wagon. A station wagon with 4-door hardtop design, this was a GM first in 1957. The famous Oldsmobile Rocket theme is incorporated into the front fender design beginning with the dual headlights and carried into the taillights. On the rear quarter, several horizontal lines in chrome and sheet metal emphasize the long fleet look of the design.

1958 Buick Century 4-Door Riviera. Outstanding feature of the Buick design for 1958 was the distinctive grille texture which featured 160 chrome squares with 4 triangular light reflecting surfaces. Flared front fender surfaces shade twin headlights and join classic Buick sweep spear at the side. A textured aluminum panel features the rear quarter design.

longer and wider cars continued, particularly in the low-priced sport sedans and convertibles.

The attention of the stylists turned to the design of front ends, as four-unit headlights with visored front fender surfaces, wider grilles with interesting new textures and sculptured bumpers emphasized the low, wide appearance of 1957-58 automobiles.

From the rear, multiple-unit taillights, specially shaped bumpers and increased glass area (made possible by thinner pillars and roofs in the upper structure) added to the low, wide look.

At the side, the body surfaces of the American automobile took on a sculptured look as many makes featured new rear quarter treatments. Rocket-themed "wind-splits," as the designers referred to raised sheet metal shapes, and sculptured missile designs were typical and popular. Some designs featured raised rear fender surfaces and many had protective side body moldings.

Another trend in the making was toward increased height in windshield and rear window glass, with reduction in the length and crown of the roof. Roof pillars were destined to become thinner and even more graceful.

Side surfaces also lost some of the rounded look and the classic "turn under" was flattened out to make room for a new structural side member used in conjunction with a newly designed X-frame. Both measures were adopted to lower the car and to decrease the height of the tunnel in the center.

One of the significant trends in automobile interiors of the

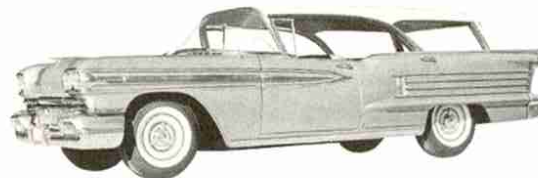
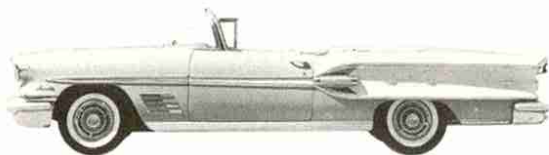

period was a sports car theme in a number of models. In certain hardtops and convertibles, modified bucket seats and assist bars for front seat passengers were features.

Interior surfaces saw a greater use of color, textured metal panels, rich fabrics and molded plastic. Steering wheels and instrument panels underwent extensive redesign, departing from conventional concepts and adding beauty to what were once purely functional elements.

The Automobile Future is Bright

If there is anything that can be said with assurance about the future appearance of the automobile, it is this: It will continue to change, to be improved, to be made safer and to become more beautiful as the years go by. Exactly how it will look ten years from now no man can tell, not even the best informed designer or engineer in the entire automotive industry. The factors that will affect appearance are too numerous and complicated. New scientific discoveries, new technological developments, or new sociological changes may revolutionize its construction and appearance. New generations of inquisitive adventuresome Americans will develop new habits of usage and new ideas about its appearance.

While it's true that no one can predict what the car of the *distant* future will look like, many skilled and imaginative people are working steadily right now to develop a new concept of appearance for the car of the *near* future—your car of tomorrow.

1958 Cadillac Sixty-Two Sedan. Cadillac combined a longer hood and rear deck with a new rear fender treatment to give a longer silhouette. A newly designed front end featured circular jewel-like protrusions in the grille, dual headlights and a new bumper configuration. All four-door Cadillacs featured hand operated venti-panes in the rear door.



Compare Your Design Taste with the Experts'

Choices of the Experts
and an Explanation of the Design Principles Involved

- 1 B is the preferred choice. In subdividing an area, division into equal parts is considered monotonous. Uneven divisions offer more variety and greater interest.
- 2 A is the preferred choice because it is better balanced. The strong arrow-like points in B pull to the left; there is nothing to oppose or balance them.
- 3 B is the preferred choice. In A the division of area follows a monotonous ratio of 1-2-3. In B, a 2-1-3 division provides a self-contained unit within a frame. B is better organized.
- 4 A is the preferred choice. The use of the three small squares on the right of the vertical black line helps bring the vertical white space into the design.
- 5 A is the preferred choice because it offers greater variety. The horizontal line divides the large vertical white area into two parts, the dimensions of which are not repeated in the third area. In B each dimension of the small area is repeated in one of the other two.
- 6 A is the preferred choice. In A the circular elements vary in size and value. Their arrangement is a good example of informal symmetry and variety. In B all elements are the same size and the arrangement is formally symmetrical. As a result it is quite monotonous.
- 7 A is the preferred choice. The large white shape on the left is well balanced by a small dark shape on the right. In B the darkness of the large area destroys optical balance, since there is nothing to oppose it.
- 8 B is the preferred choice. The lone circle in A seems out of place because it is unrelated to other parts of the design. In B a repetition of circular elements given meaning to the circle.
- 9 B is the preferred choice. Repetition of the same size dark shape three times in A ignores the problem of balance which is solved nicely in B by varying the sizes of the dark areas.
- 10 B is the preferred choice. Here a series of similar shapes creates a feeling of movement through rhythmic repetition. The arrangement of elements in A lacks this relationship and the design tends to disintegrate.
- 11 A is the preferred choice because the axis of the two dark areas change direction and guide the eye back into the design. In B the axis are parallel and the eye moves from top to bottom with nothing to interrupt the movement.
- 12 A is the preferred choice because the directional forces or planes counter-balance each other. In B all forces are located on one side and point to the left causing an unbalanced condition.
- 13 A is the preferred choice. Better contrast is produced through the use of a wide range of values. With a narrow value range definition of the shapes is not established and the result is monotonous.

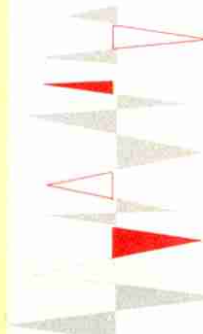

Modern Automobile



"Y JOB", 1938, first significant experimental car in the U. S. It was so far advanced that ten years later it attracted attention in public appearance. It had many features that eventually became standard on production cars: low silhouette (54 inches high), front fender extended into the door, extensive rear overhang, catwalk cooling, recessed tail lamp, and first electric power operated convertible top and windows. It was the first car to have disappearing headlights and an automatic cover for the convertible top-well.



"LeSABRE", 1950, a low slung, racy job with the first panoramic windshield. Having top and windows that are actuated by rain drops, LeSabre is rainproof. Its convertible top opens in two stages, one of which permits easier access to the seats. Its egg-crate grille, sweep spear with textured panel, notched belt line and beautifully proportioned form represented significant new styling trends.



XP300, 1950. In addition to its advanced functional styling, the XP300 had many mechanical features: supercharger, supplementary carburetor which feeds methyl alcohol, adjustable steering wheel, adjustable seat back, built-in hydraulic jacks.

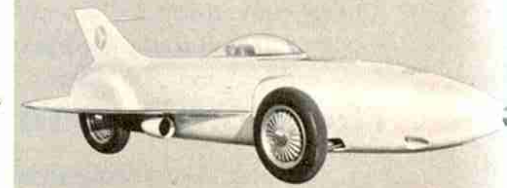

"FIRE BIRD", 1954, first turbine propelled automobile in the United States. Not intended for production or even for use on highways, the Firebird is an earthbound version of the Douglas Skyray, famous U. S. Air Force jet fighter.

Famous GM Research Laboratories on Wheels

The idea of the modern dream car or show car, as it is popularly referred to, originated with the General Motors "Y Job" in 1938. Not to be confused with sports cars and foreign cars, the dream car is an experimental laboratory on wheels doing customer research in the aesthetic appeal of radical new design ideas. New engineering and safety developments are included. Features, innovations and concepts that prove to have wide appeal eventually find their way to production models.

When the "Y Job" was developed, this process of adoption was relatively slow, taking several years, but today new ideas sometimes become available to the consumer, within a few months after the first unveiling. That's because people today seem to be willing to accept changes far more readily than they were 20 years ago. Shown below are three dream cars of recent years that proved to have such great appeal that production plans were started immediately.

Pontiac Safari



Chevrolet Corvette



GMC Truck and Coach L'Universelle



Stylists Design a Dream Car



Buick Wildcat III

Of all the useful and beautiful products designed by Stylists, the best known and most appreciated is the American automobile, which ranks second only to women's fashions in the attention given to changing and improving its appearance.

Because of the complexity of the problem, automobile designing is seldom the work of any one individual. Before the design becomes a reality scores of people contribute ideas and suggestions and even objections that influence the design. It's teamwork that produces beautiful designs, a fact that becomes evident in the ensuing story.

What little we do hear of the individual automobile Stylist is usually in connection with automobile shows, where he is associated with an atmosphere of glamour and excitement. His new car, demonstrated by beautiful models, revolves on an elevated turntable before the admiring gaze of thousands of people. Broadway revues and famous personalities add to the atmosphere of glamour.

When the rest of us are enjoying current models, the automobile Stylist is feverishly working, not on next year's model, but on one for the year after next. He is always two years or more ahead of the public, 18 months or more ahead of the assembly line, 12 months ahead of the production engineers, and 6 months ahead of his own fabricating shop.

Cadillac Eldorado Brougham



Because of the importance in such a highly competitive field of keeping new designs secret, the automobile Stylist works in a building surrounded by guards, in a room that is always locked (even in big companies the keys are mighty scarce.) All details of the design including preliminary engineering drawings are prepared within the studio.

In recent years, another activity has been added to the duties of the automobile Stylist—the design of dream cars intended to stimulate interest in good design and test public reaction to new ideas.

Every good automobile Stylist would give his eye teeth to design a show car or dream car. Here's an assignment with freedom from production restrictions. It is a chance to try new effects, to use more expensive materials—to design a car that's "farther down the road," to use the designer's lingo.

The picture story on the following pages traces just such a car through the stages of its design—from the initial idea to the finished dream car.

Here you get a glimpse of the endless change and refinement that is part of any creative design process.

After initial planning and discussion, the Stylists begin to develop a theme based on the signals management has given them. In the example described here, the problem is to design a four-passenger convertible on a short wheel base (110 inches) and still maintain comfort, accessibility and safety.

As the Stylists test their first ideas on paper, engineers and draftsmen establish critical dimensions and design a special chassis. An extra heavy frame, powerful engine, special tires, and many new mechanical features are provided.

The Stylists do most of their creative thinking on relatively small sketches, the best of which are developed into full size line and air brush drawings.

Finally, a full size clay model is prepared. The clay model is the proving ground of the three-dimensional quality of the design. When completed it also serves as the model for making an actual full size prototype, or sample car.

A glance at the photographs on these pages will reveal the evolutionary nature of the sketching and modeling process. Notice how the original sketches (p. 52) differ from the final design (p. 65).

From time to time, sketching and modeling stop and the clay mockup is presented to the eager yet critical eyes of other designers and company officials (see p. 58). These interruptions are the trial balloons that test the reactions of others. The Stylist is very attentive to the comments and criticisms he receives. The result is a design which has a better chance of good acceptance when presented to the public.

When after further development the clay mockup is finally approved, a Fiberglas prototype model is built. In a car intended for quantity production, a number of handmade sheetmetal bodies would be built, as a preliminary to designing the car for mass production.

But this car is not intended for actual production so the final result will be the Fiberglas body. The first step in making a body of Fiberglas is to cast a complete plaster mold of the entire surface as well as of all structural members.

When construction of the chassis is complete, the Fiberglas body parts are assembled. Then in the metal shop, "hard" trim parts such as bumpers, grille parts, moldings, etc., are fabricated and fitted. After chrome plating, all metal parts are then assembled. The last assembly operation is installation of "soft" trim which includes floor covering and upholstery.

Finally the appointed day arrives and the car is displayed to the public. To see how people reacted turn to page 65.



Dreaming and Planning a Design Theme



Overall objectives are established by an administrative group made up of studio designer, engineering supervisor, fabricating shop head, and administrative executives.

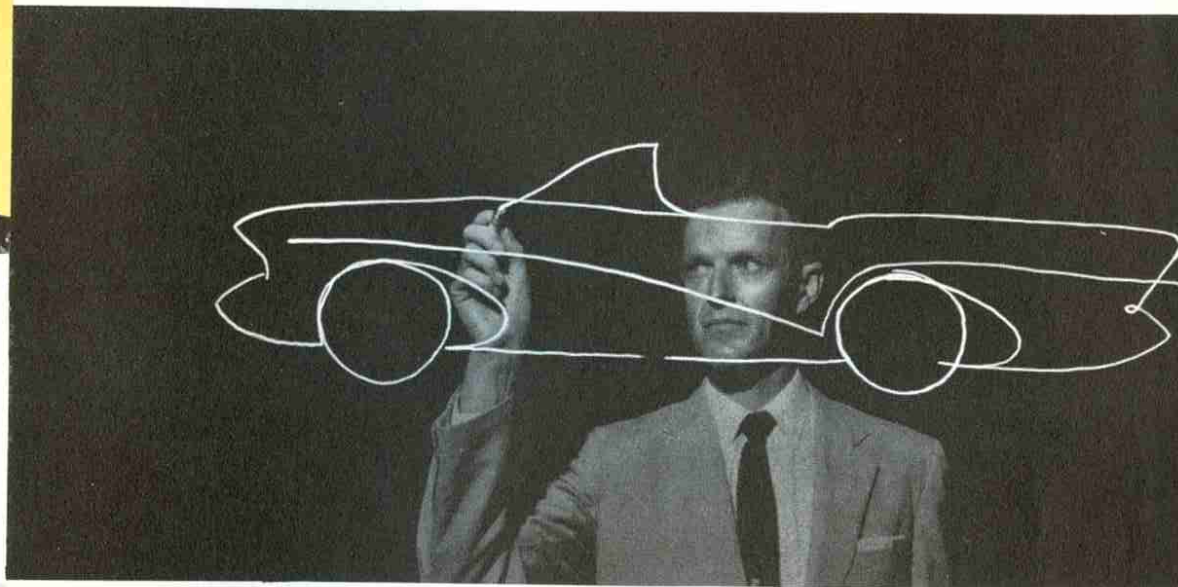

Symbolizing the workings of a creative mind is this flashlight painting. In a darkened room before an open camera, a designer draws lines of light in the air—lines suggestive of the car his group is preparing to design.

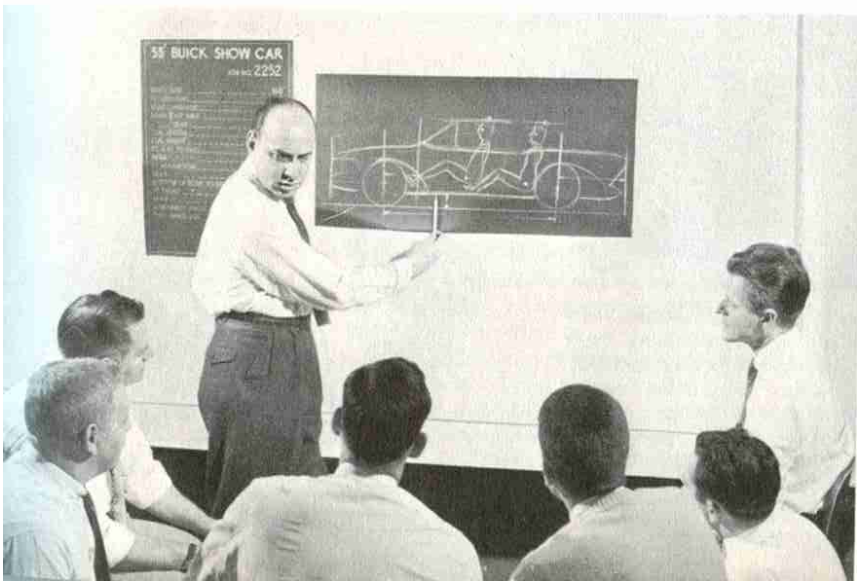

The design problem is outlined. A four-passenger convertible sports car on a short wheel-base—110 inches. Performance and maneuverability—in the sports car class. Height—as low as possible. Access to front and rear seats—must be easy to enter and to leave. Studio design group includes chief designer, assistant designers, mechanical engineers, draftsmen and clay modelers.

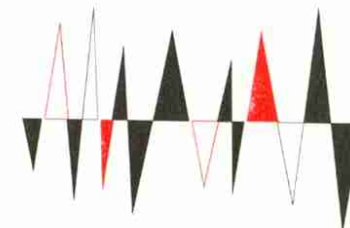



The Theme is Developed on Paper

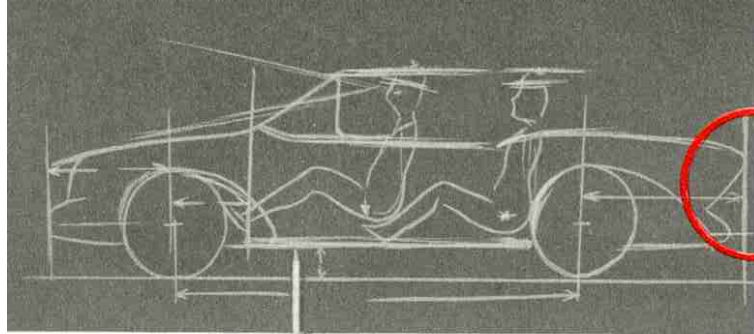

Rear end treatment shown here was well received and when modified actually became a part of the final design.

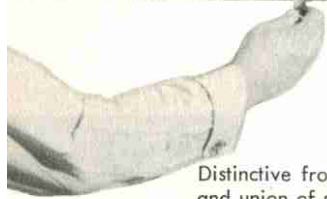

Distinctive front end, exhaust openings at side, and union of sweep spear with other body lines feature this effort.

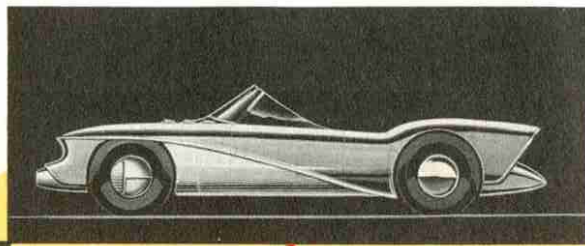

Raised cowl and cape-like rear roof treatment gave this car an unusual appearance.

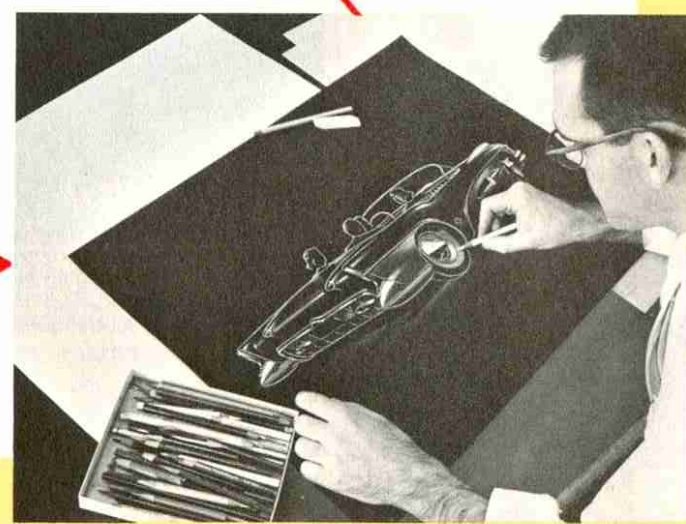
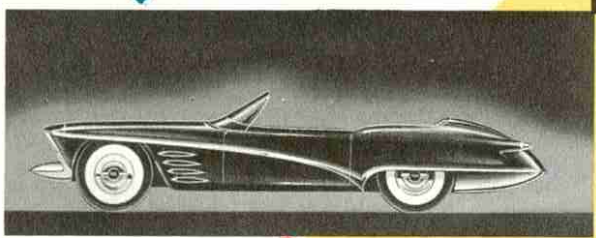
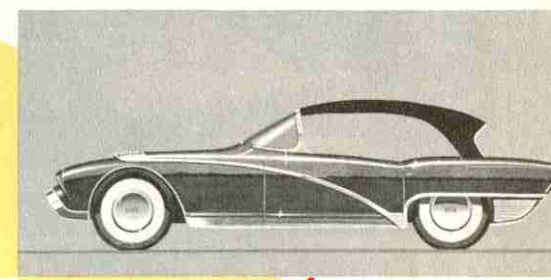

First step is to make dozens of small scale sketches which vary greatly in concept but conform to established limits of wheel-base, overall length, and height. Pastel colors show up as highlights on the black paper which is the favorite sketching medium of the Stylists. As a starting point for more serious consideration the choice narrows down to two sketches (right) which combine several desirable features taken from the other efforts shown left and above.

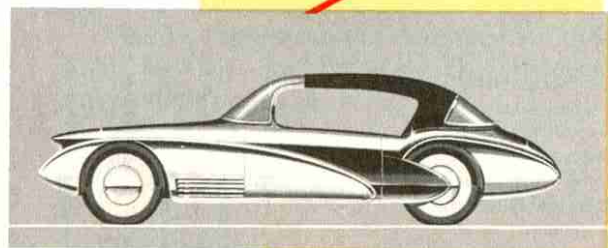

New idea in windshield is curved in two directions and extends into roof panel. Note partial cover on rear wheel opening.

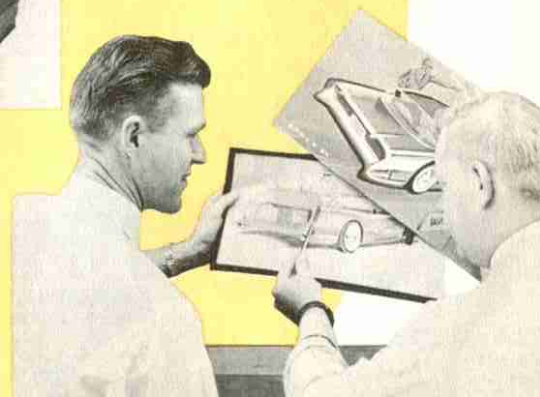

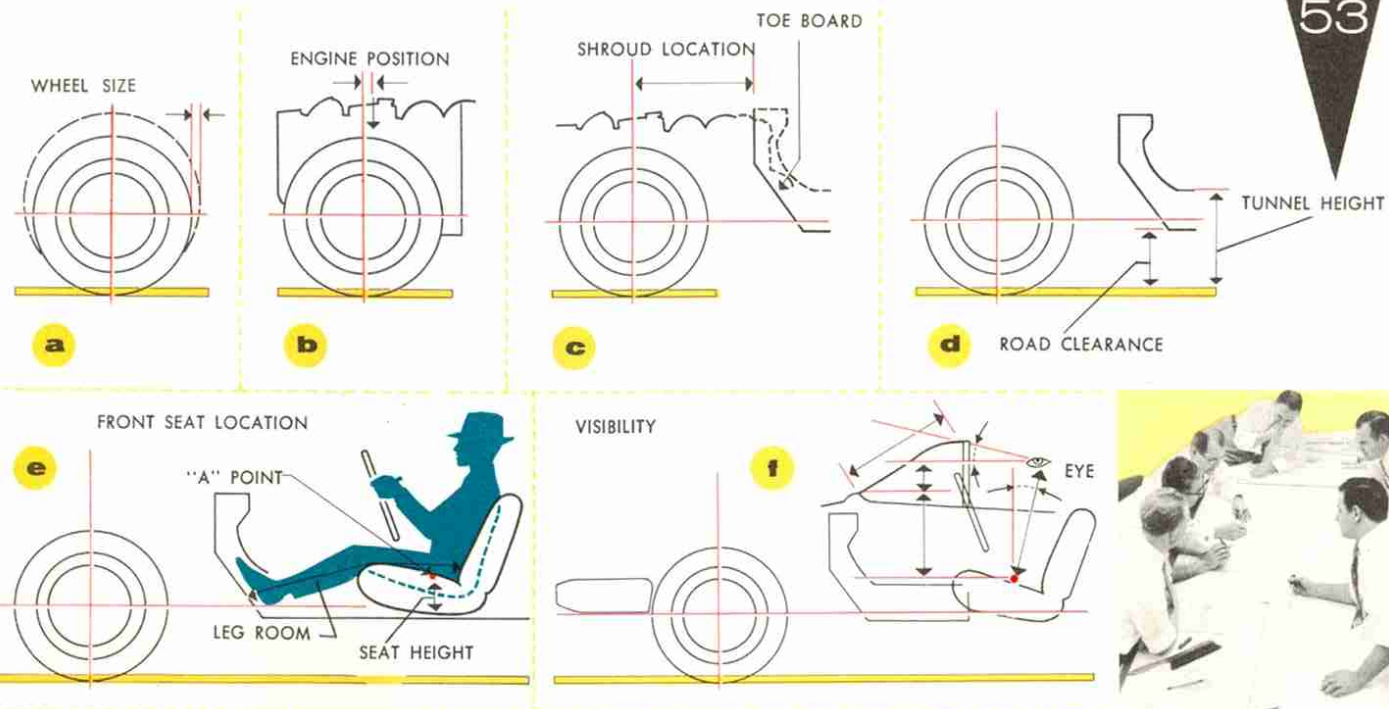
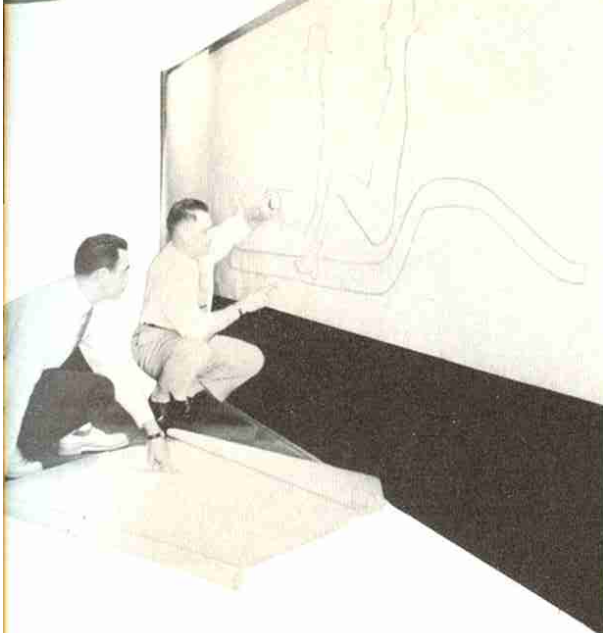

Engineers Design Chassis and Establish Principal Dimensions

The closest kind of cooperation between the designer and the engineer is required in the design of a new automobile. The engineer lays out the chassis which includes frame, engine, transmission, suspension system, etc. In addition he cooperates with the designer in designing the body. While the designer is developing the body surfaces, the engineer is designing the structural members and assisting in establishing the principal dimensions (above right). In this case the problem was complicated by such limiting factors as a very short wheel-base, an extremely small vertical height and a relatively large passenger compartment.

- a** Reducing the wheel size (a) above by $1\frac{1}{2}$ inches allowed engineers to move body forward slightly, providing needed room for the rear seat.
- b** Engine location is determined by engineers for best weight distribution, a factor in safe vehicle operation.
- c** Engine position puts limit on forward location of body proper and locates the shroud or fire wall.
- d** Provision for propeller shaft and its clearance locates the tunnel. Minimum road clearance affects floor height. Within these limits is built the underbody or floor.
- e** Design and location of front seat are based on dimensions of average Americans. Seat height, leg room and "eye" point are measured from the classic "A" point, the point of greatest weight concentration.
- f** Size of windshield and its location in relation to eye point are factors in visibility which receive careful attention.
- g** Access to rear seat was aided by providing four inches forward motion in the front seat. Rear seat leg room was increased by designing foot wells in the under body. Note how rear seat location is limited by frame and suspension system.
- h** State laws specify location of headlights and taillights, set limit on maximum width among other things.

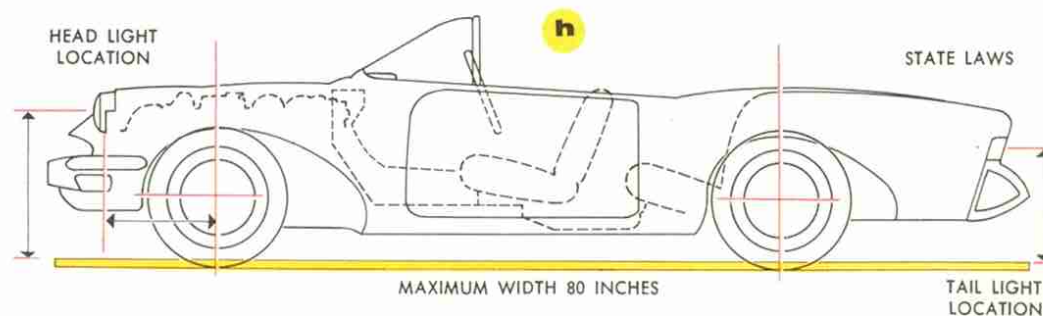
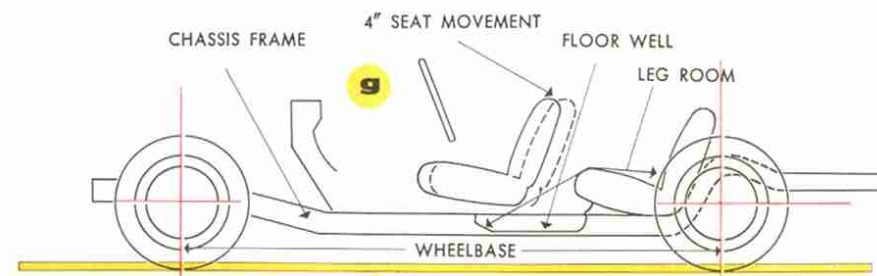



Clay modelers position windshield on wood armature. Slatted construction anchors clay.

**Base For Modeling
a Full Size Car—
Clay Covered Armature**

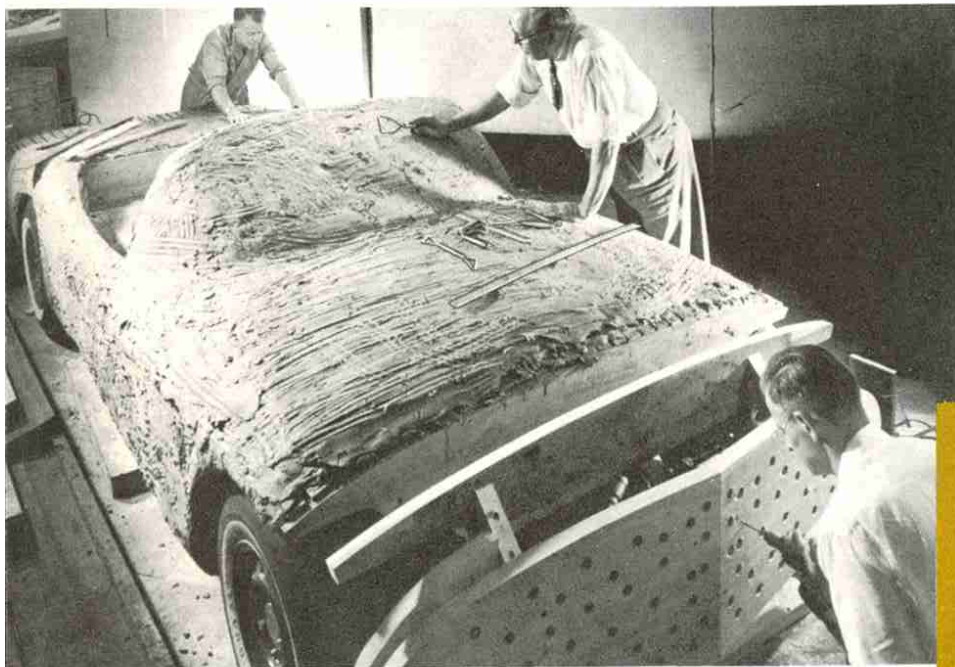

Clay heated to 150°F is applied with a thrusting motion to eliminate air bubbles.

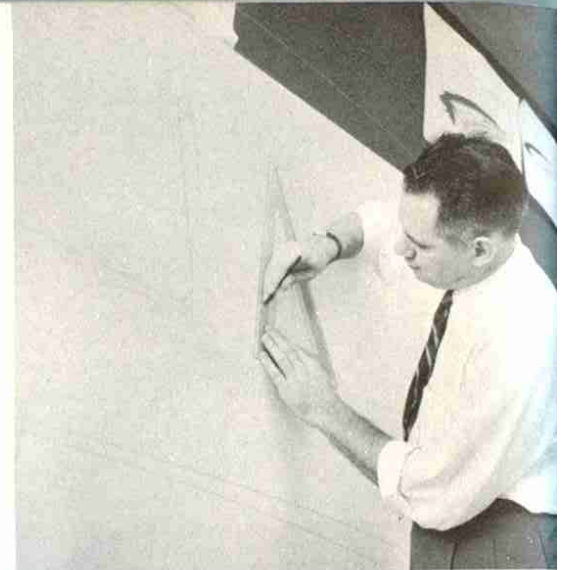
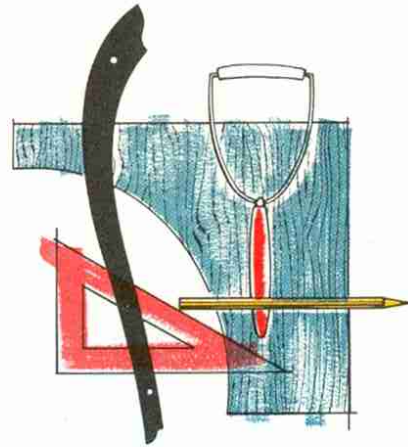

Designer converts small scale sketch into a full size line drawing. In the process he begins to develop and refine the design theme. Lines developed here are duplicated in wood templates and used to control the clay surface.

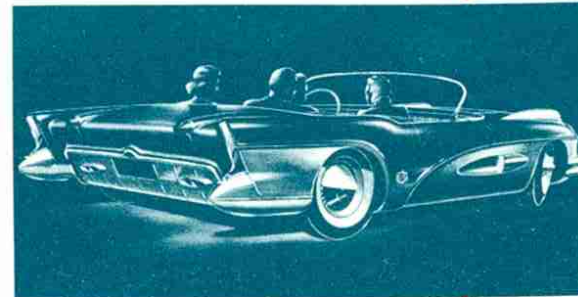

When cold, clay is firm and hard. It must be cut and formed with special tools such as the scraper shown below, right. Other modeling tools: "slicks" for smoothing, "mouse" for scribing lines, depth gauges, highlight (radius) gauges, fillet tools and extrusion dies.

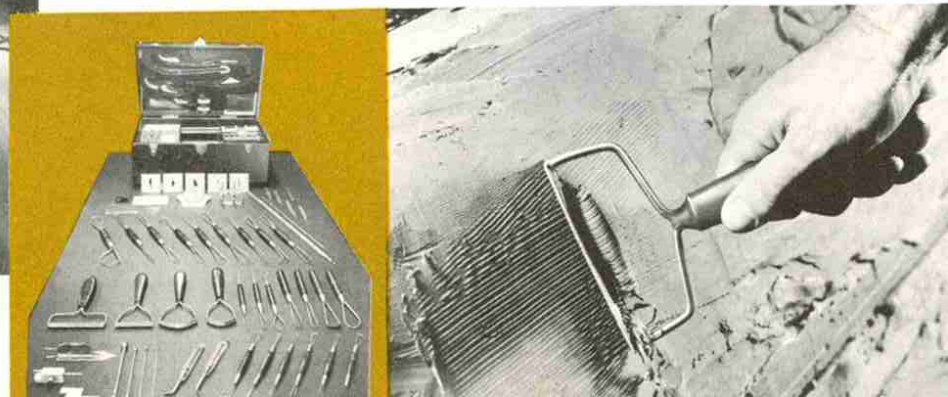

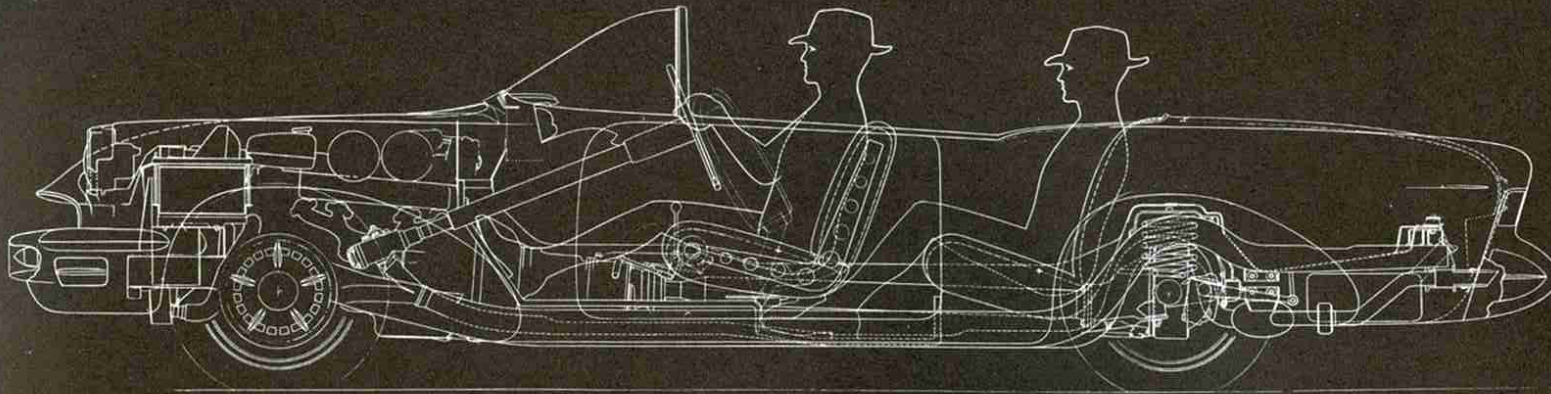

Full size blackboard drawing shows principal outlines and location of mechanical components as seen from the side. This was once the final design stage.

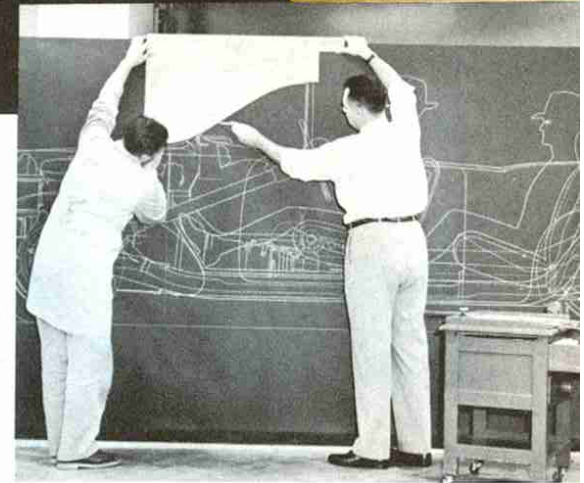

Clay modeler and designer check a windshield template against the drawing before imprinting its outline in clay.

Surfaces are Developed by Lines Drawn on Paper, Cut in Wood, Impressed in Clay

A line drawing of any one view is insufficient to describe the complex surfaces and contours of an automobile. In the side view (above), the lines we see are outlines at the center of the car, of the fender, etc. The contour of the windshield, for example, defines its shape only at the center-line of the car. A template of this line (right) will be helpful to the same limited extent in shaping the clay. This is also true of hood, fenders, deck and any other part of the car. You can see that a network of lines is needed to control these complex surfaces. Here's how it's done in actual practice.

The armature is set down on a level surface (right below) and surrounded by four flat surfaces on which are marked reference lines called "inch lines." Along the side, the "0" inch line corresponds to the shroud of the car and all measurements in a lengthwise direction start here. Across the front, the "0" inch line is the center of the car. Other important reference lines, including vertical inch lines, are shown in the sketch at right.

Contour templates are then made for intervals of every 10 inches, or oftener if necessary, along the length of the car, across its width, and from top to bottom. All of these lines originate on the full size drawings, which in turn are developments of the designer's sketches.

On the following page are pictured some of the different templates in actual use.

The surface development drawing at right is an expansion of a full size drawing of the front end. The lines detailed here are the important section lines used to control the front fender and hood surface. One of these lines and its template is located in the drawing at far right.

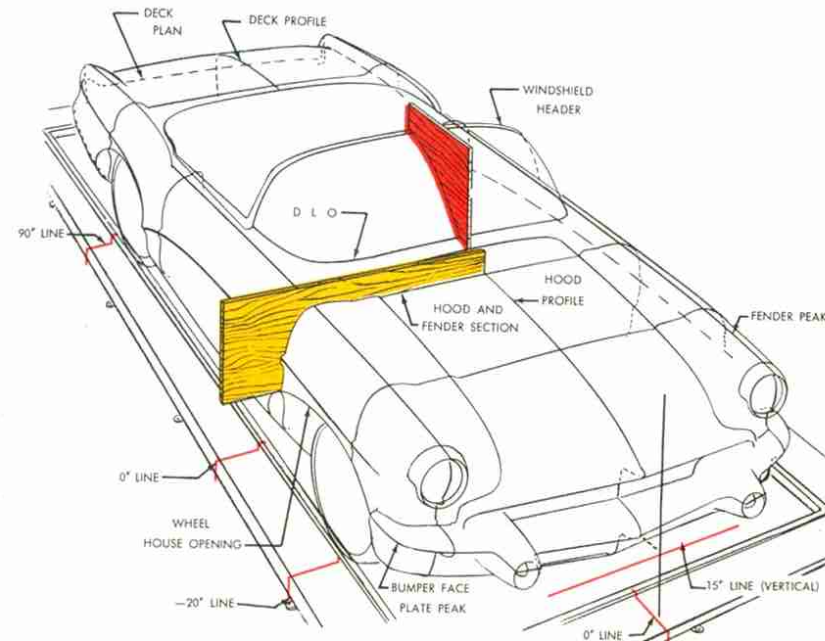
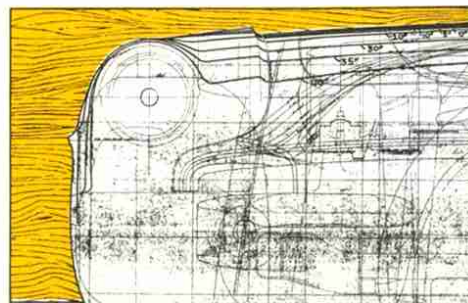



Modelers in foreground work on near side with template taken from and matched to opposite side. The result is two identical sides.

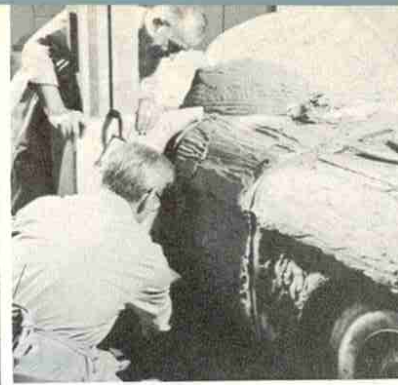

Here a template is carefully positioned at the proper height on the 20 inch line.

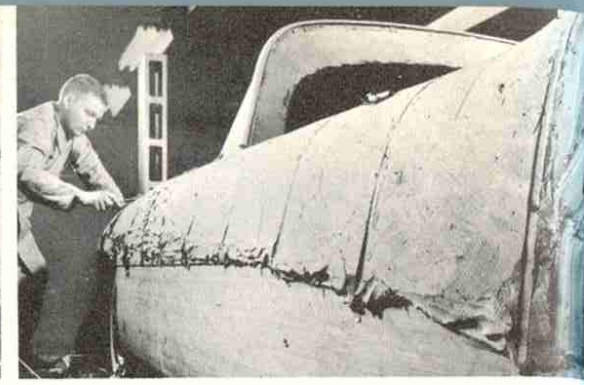

Series of contour lines at belt line just before excess clay is cut away.

Drag template forms surfaces that are parallel to the surface plate.

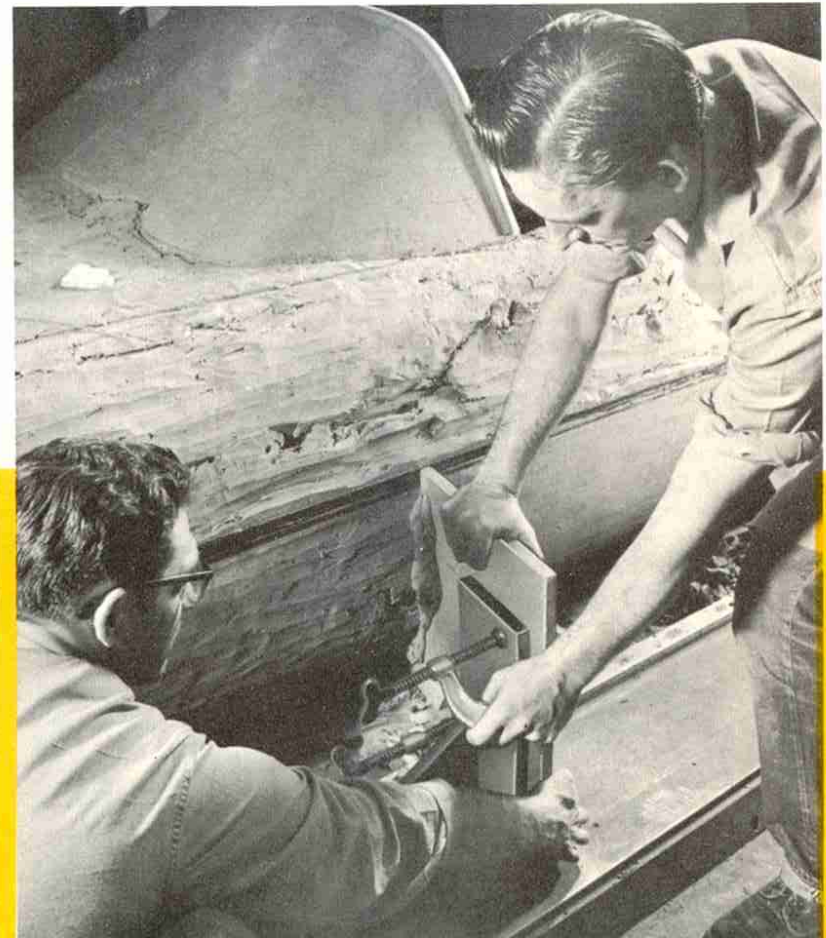

Fine details such as the Wildcat emblem pictured below are first sculptured in clay. Imperfections in the clay are worked out in a female plaster form, which becomes a mold for an exact plaster likeness.

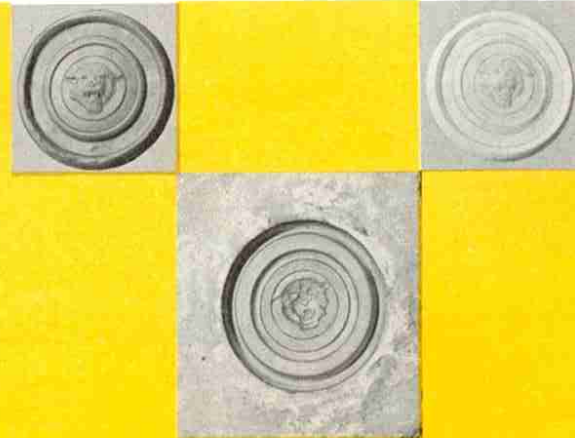
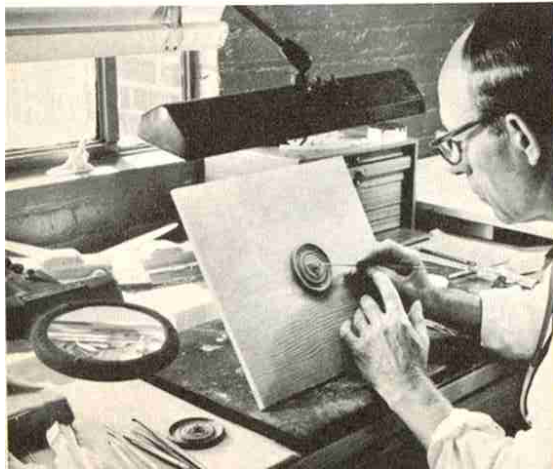

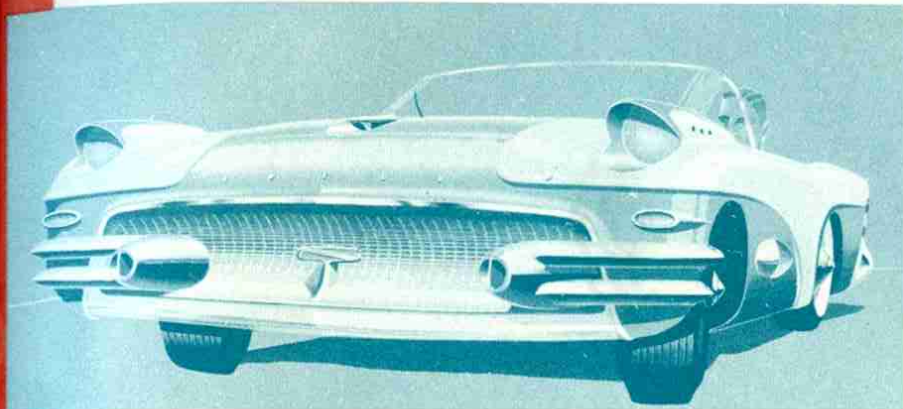

Detailed air brush drawing which was the basis for modeling the clay mockup shown below.

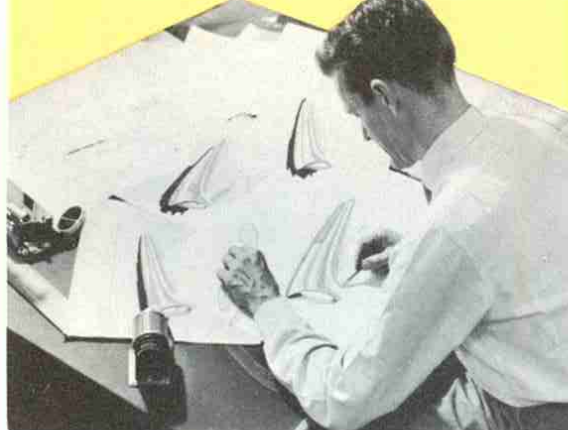

Several variations of a headlight detail are worked out by designer. Used in conjunction with a speed line that starts at the hood and merges with the sweep spear at the side (see below) this feature was later dropped.

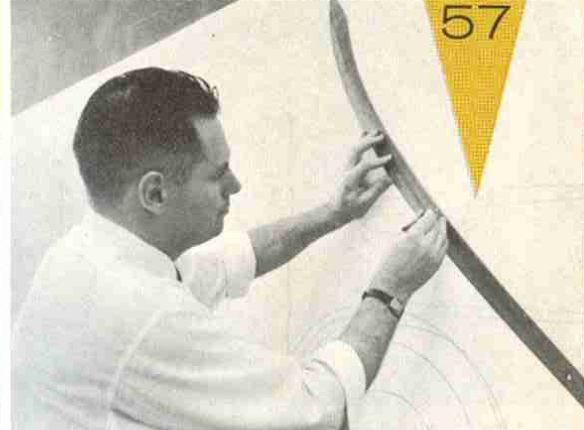

Designer keeps adjusting full size drawing to agree with most recent sketches.

Endless Sketching and Modeling Develop the Three-Dimensional Design

Completing the clay mockup prior to addition of headlights and grille.

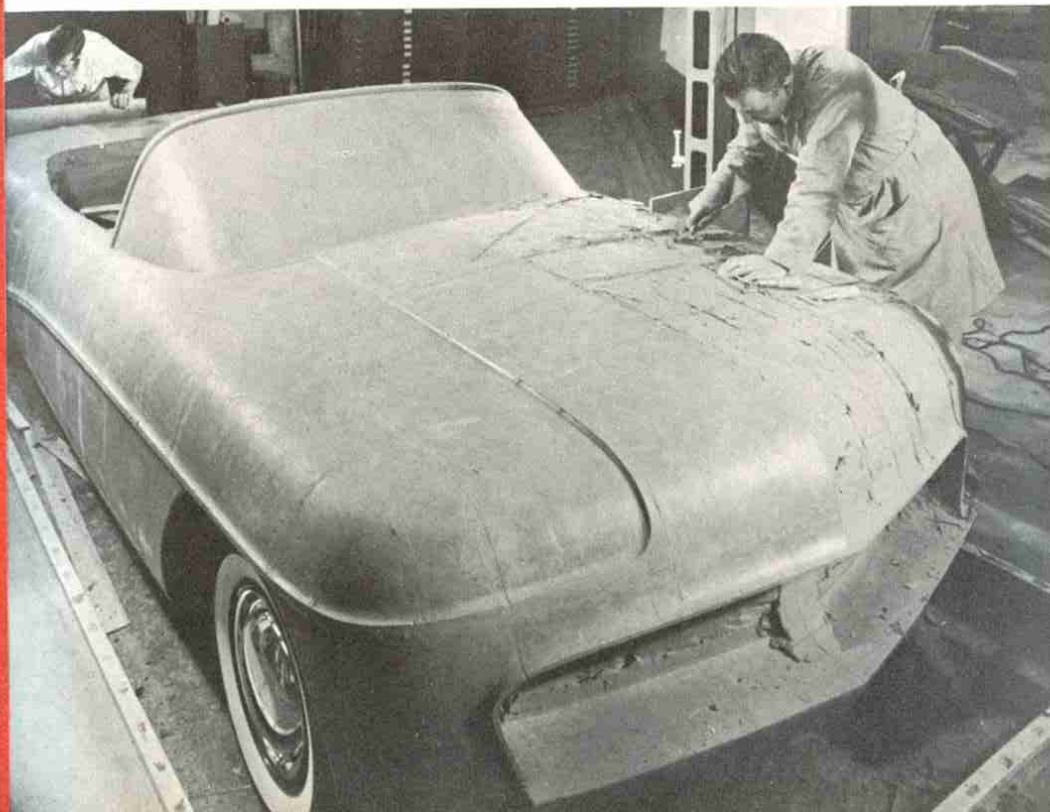

Evolution of taillight assembly.

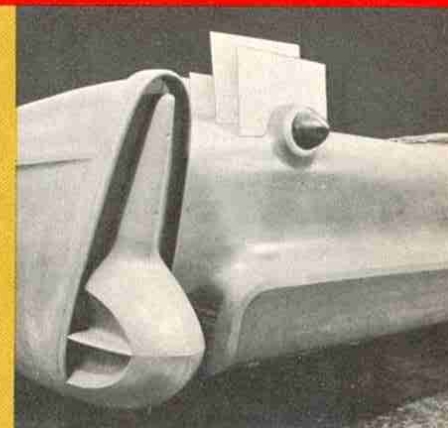
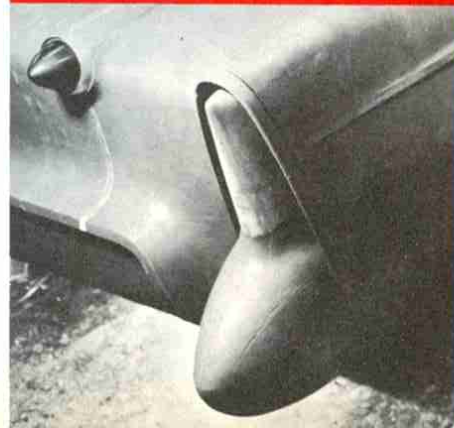
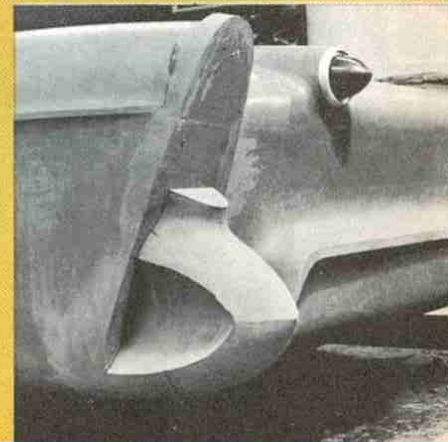
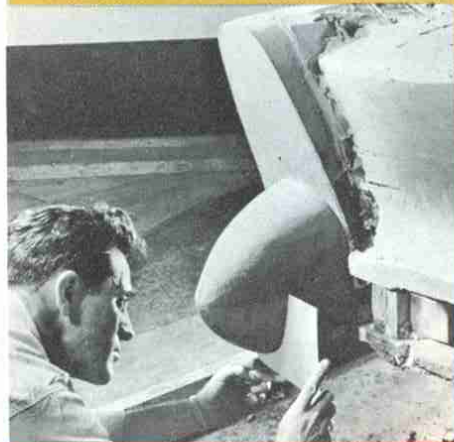



Smoothed by plastic slick, clay takes on sheen.

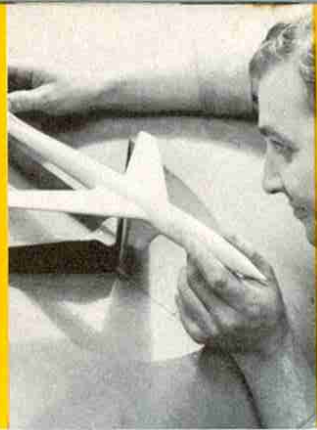

Clay modeler prepares to install hood emblem.

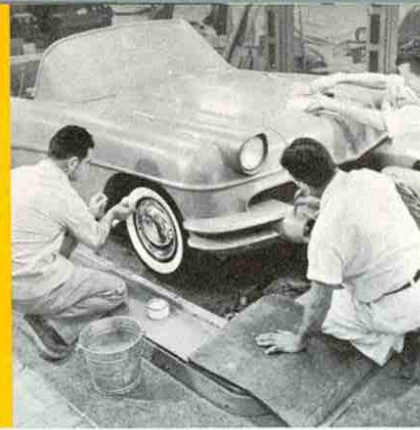

Wheels are cleaned, wood inserts painted.

Last Minute Preparations For the First Test Reaction

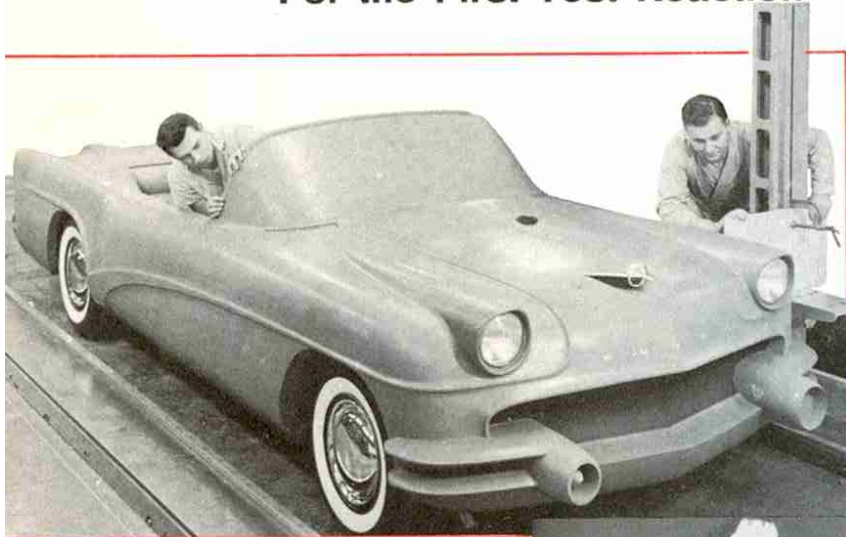

The beautiful product of months of exhaustive work, incorporating the best efforts of several dozen skilled people. Is it the final answer?

Hurried consultations, complete absorption reveal the tenseness of the last minutes prior to the first showing.



A Once Over By Experts: The Dream is Bared and Shared

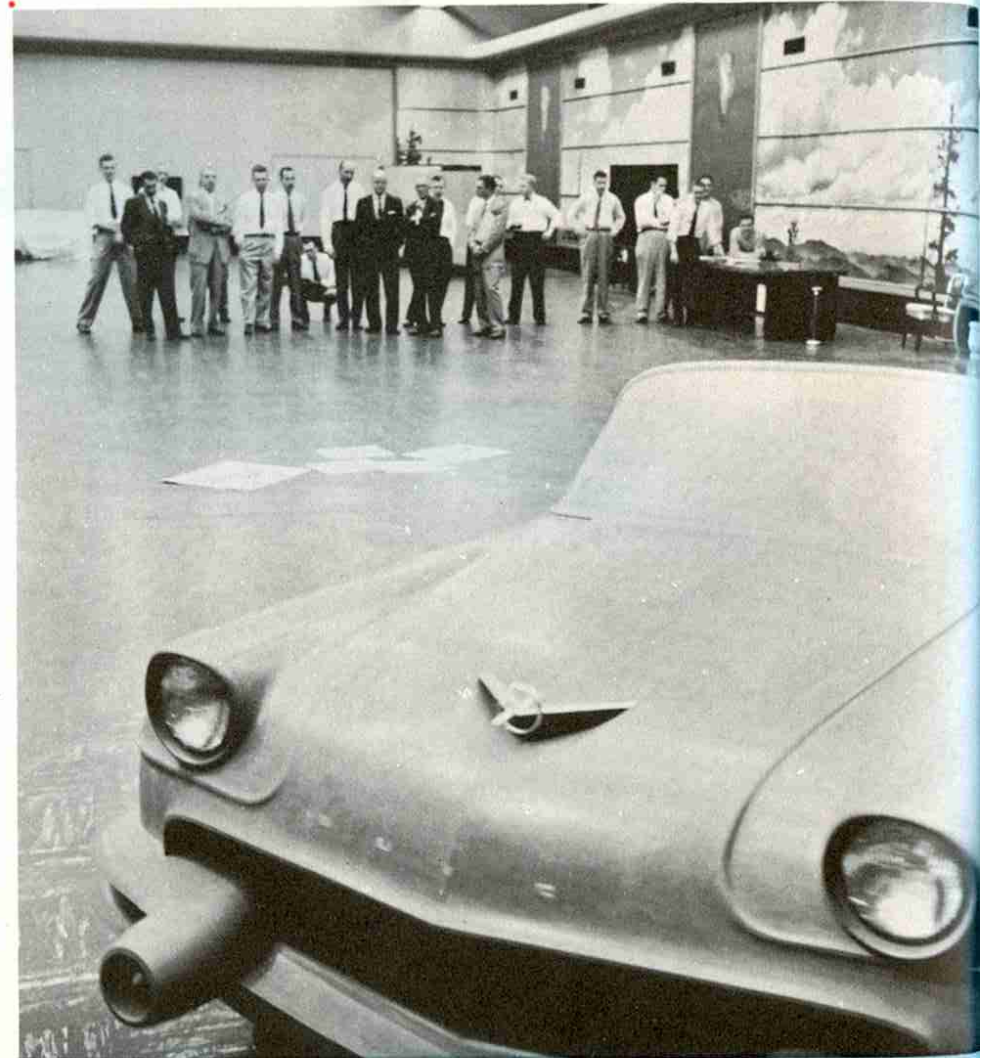

Rotating on a floor-level turntable, the car is viewed from a distance by inspection group. The car's designers know that the first impression is critically important. Papers on floor will be used to explain unfinished details.



The verdict: Nice handling of difficult problem. Suggest altering some details.



Rear overhang too heavy in relation to other dimensions?



How to shorten and still retain much needed trunk space is a problem.



Front end profile too heavy at bumper?



Hood plateau could be raised for better definition.

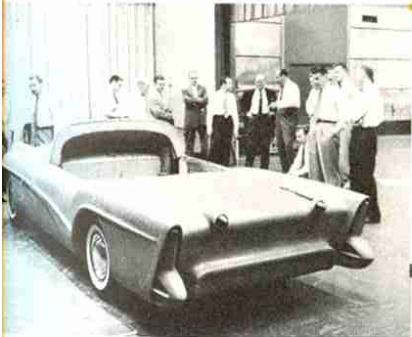

At the front

INSPECTION ON ALL SIDES



At the side



At the rear

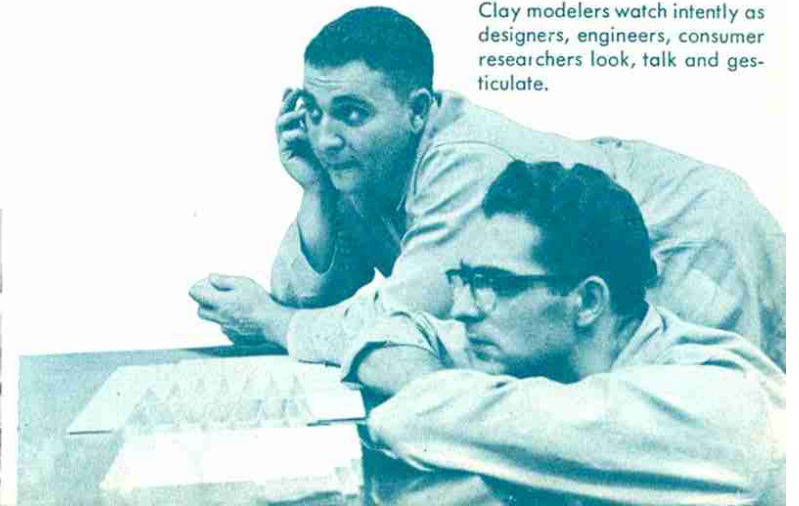

Clay modelers watch intently as designers, engineers, consumer researchers look, talk and gesticulate.

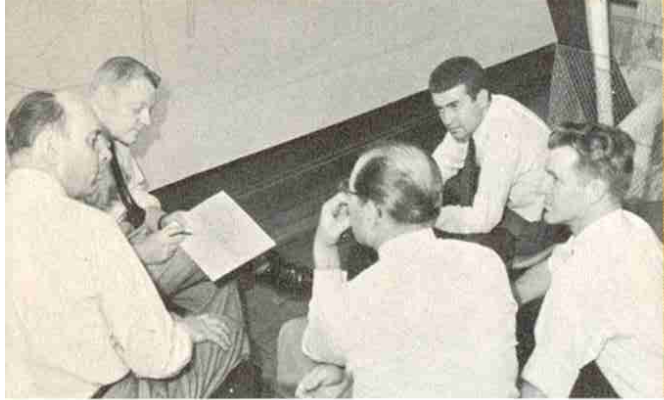

The studio design group, after discussing criticisms and suggestions, establishes a new approach for sketching and designing. How to incorporate worthwhile ideas without destroying main theme is major problem. This explains why flexibility is a prerequisite for the modern Stylist.



The new side view. Although overall proportions have not changed, the effect is completely new.

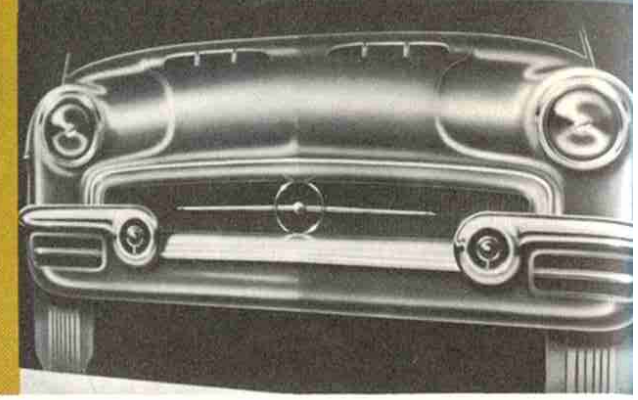

The new front end, a wider, less bulky version of the old design. Compare these full size wash drawings with later clay and Fiberglas versions to fully understand the limitations of drawings.

Out of the Reactions of Others is Born a New and Better Design Concept

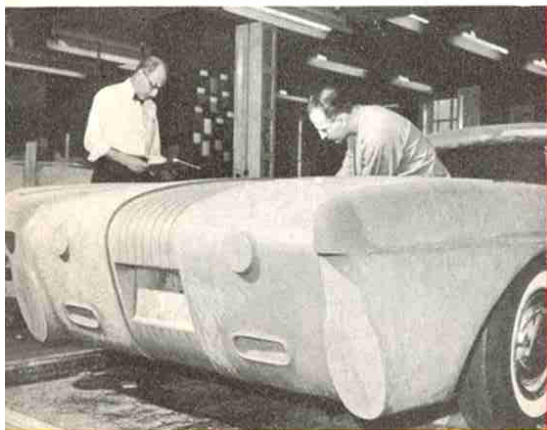

Rear fender extends over taillight.

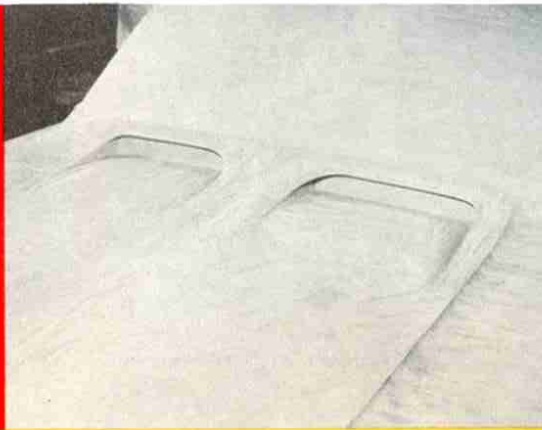

New type air intake included in hood.

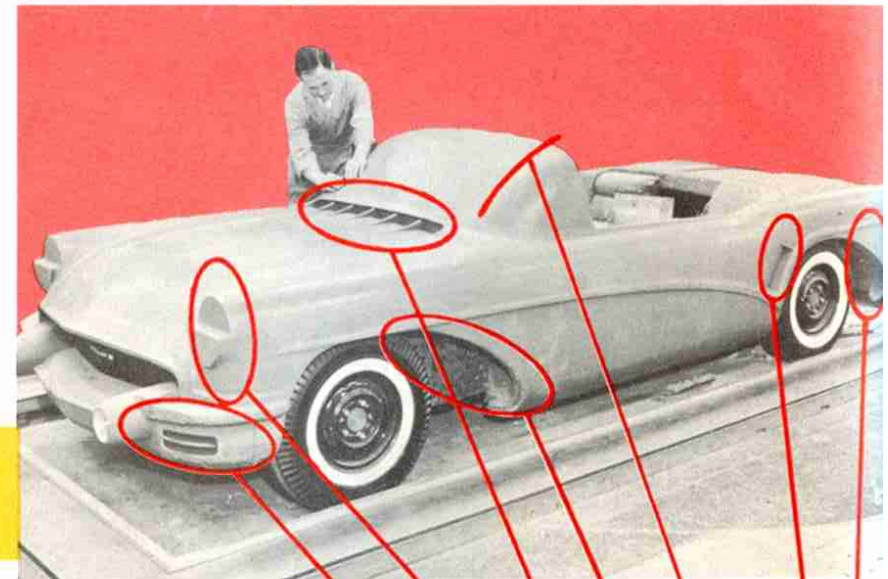

Air scoop for cooling brakes.

Fender cut away for racier look.

The finished (almost, at any rate) design in clay, ready for the plaster crews. Note changes between this version and the previous clay mockup shown at right.

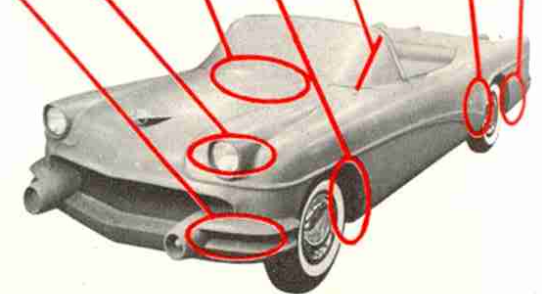
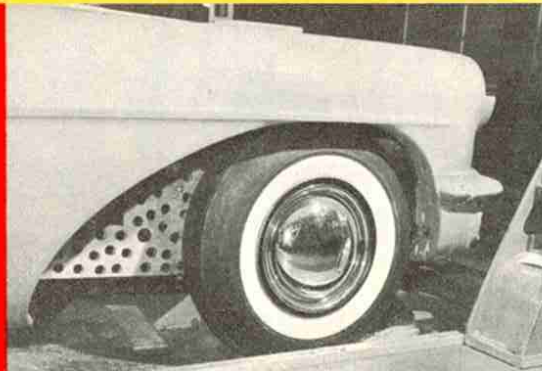



Designer at work on early version of instrument panel design.

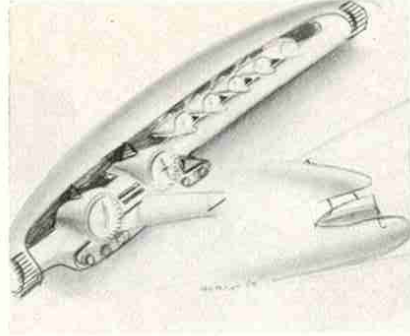

A design theme begins to emerge. This was the basis for proceeding with a full size clay model.

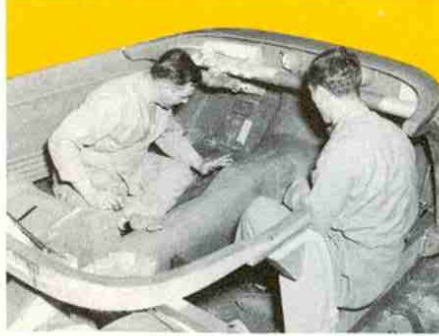

Partially finished instrument panel in background. Modelers work on other parts of "trim buck" as the wood and clay model of the interior is called.

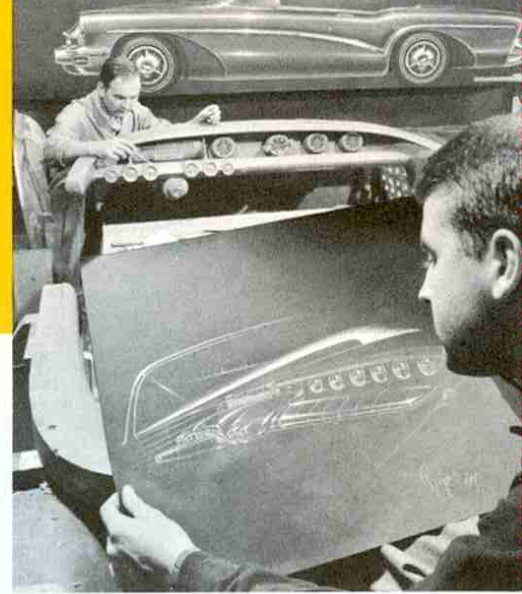

Instrument panel coming to life as modeler puts on final touches on clay version. Designer holds early sketch.

View of the finished interior. Swivel seat was introduced as an easy-enter feature.

Only a Step Behind: Design of the Interior and Instrument Panel

Clay mockup of back seat and rear inner quarter panel. Frame work at left of clay supports cushions and tests comfort.

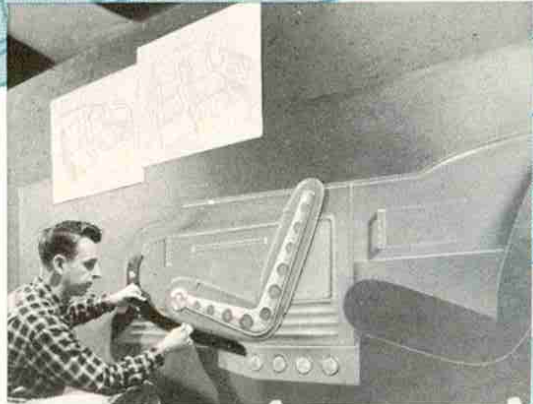

Interior designer finishes front seat on full size rendering. Pencil sketches in background show other views of front and rear seats.

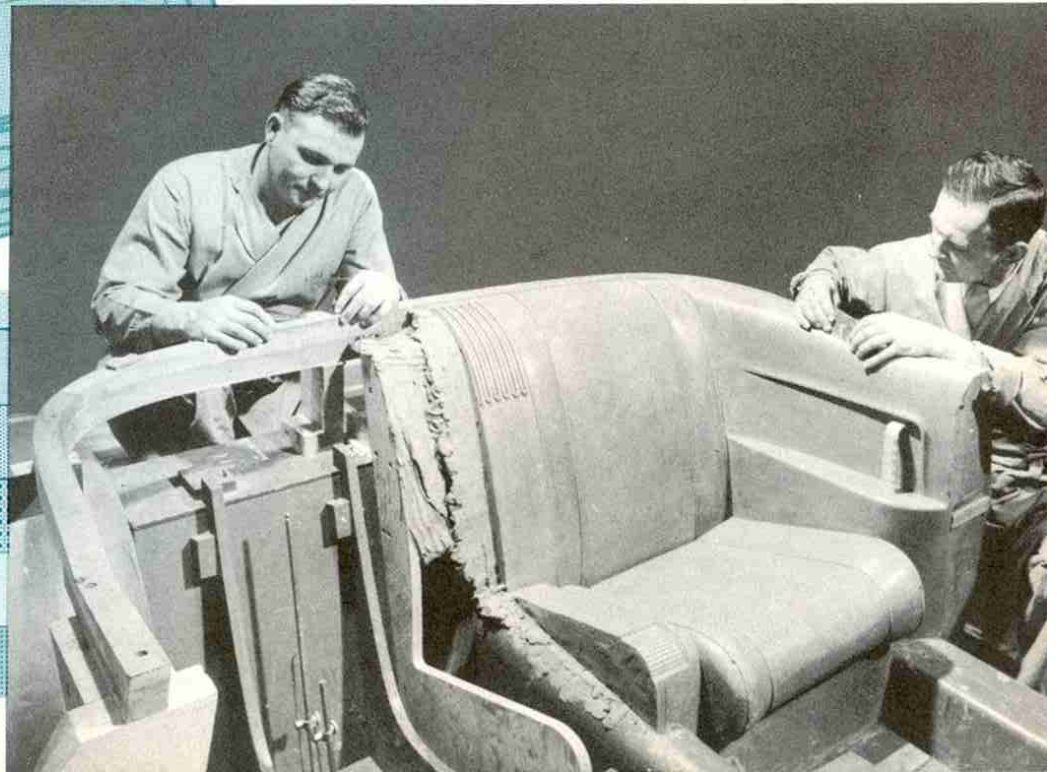



Door section of clay mockup, already sprayed with latex, is coated with wax to enable plaster and clay to part easily.



Plaster, water and Manila hemp are readied.



Thin plaster solution is slung on first, followed by thicker mixtures.



Plaster soaked hemp, the next layer, gives bulk and strength to the cast.

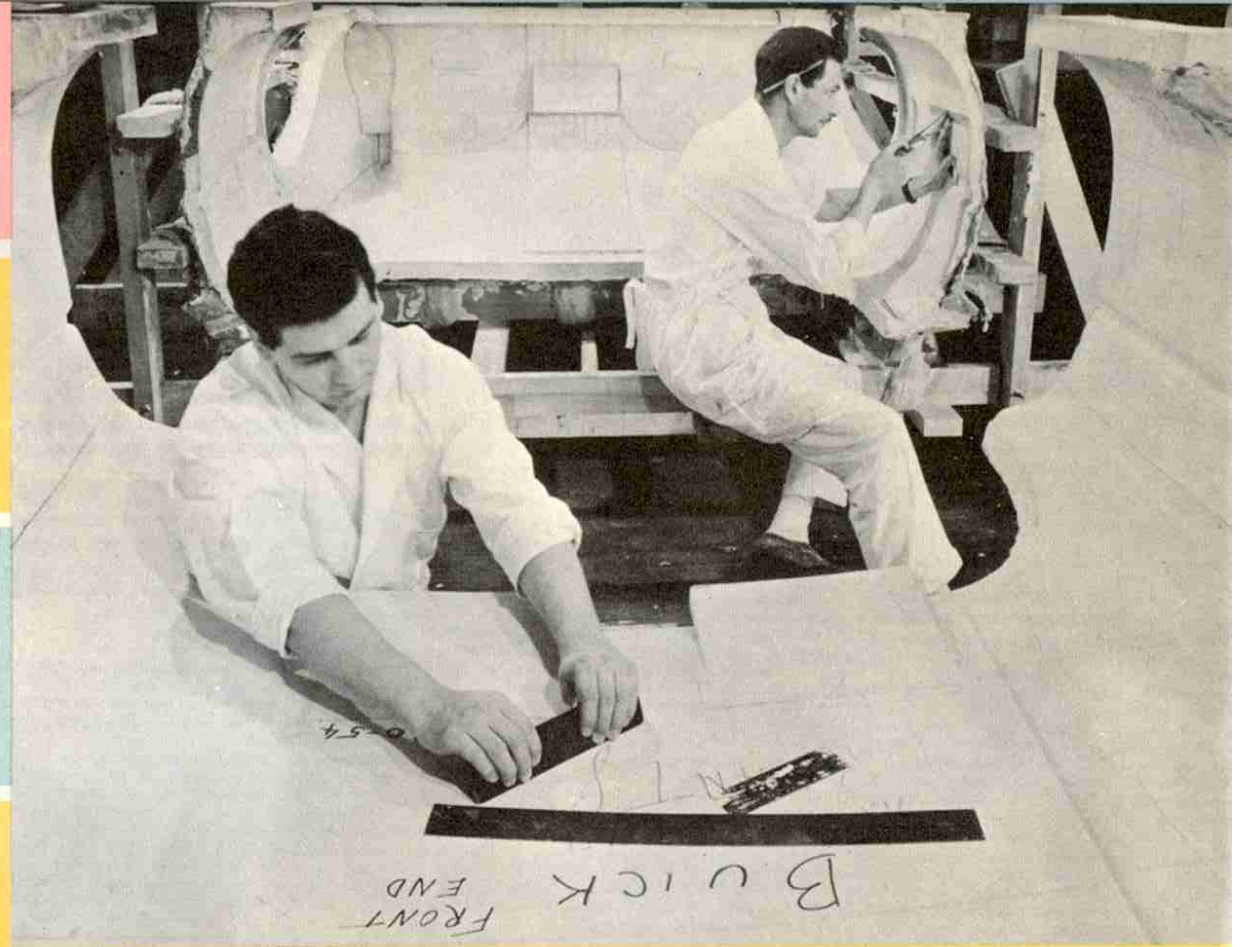

Upside-down plaster cast complete except for door sections. Workers will fill cracks, scrape irregularities and correct slight defects that were not detected in the clay. This is the surface that will mold the Fiberglas shell.

Precision Plaster Casts of Clay Surface to Mold the Fiberglas Body



Wood frame is attached to cast by strands of soaked hemp.



After plaster has set, cast is removed.

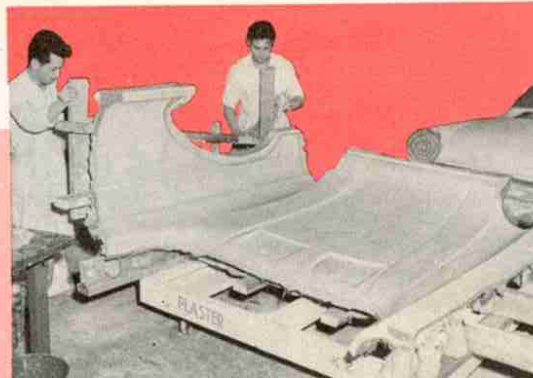

Plaster cast of hood and right front fender with clay mockup of car in background.

Not all plaster work is limited to reproduction of body surfaces. Many fine details are developed in the plaster sculpture studio. Hood ornament shown here was proposed, not used.

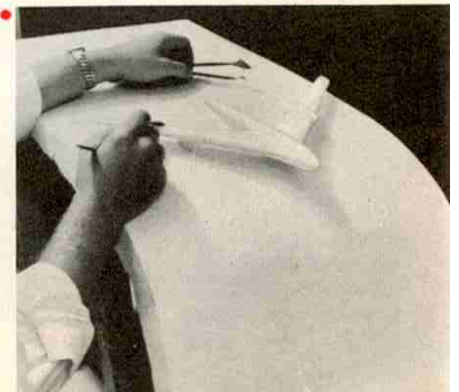

The plaster mold and each layer of cloth are coated with polyester resin. Only the first coat is dye-saturated, but as each succeeding coat is applied to the cloth, the dark color of the initial coat shows through. Note streaks in photo below.



Front fenders in reinforced Fibreglas are held together by temporary wood supports.



Fibreglas cloth is cut in pieces and carefully fitted without overlapping to assure uniform thickness of shell.



Removing a section of plaster mold exposes right front fender surface. Baking Fibreglas shell at 150°F accelerates the drying process.

Molded Fibreglas Parts are Assembled to Chassis Frame

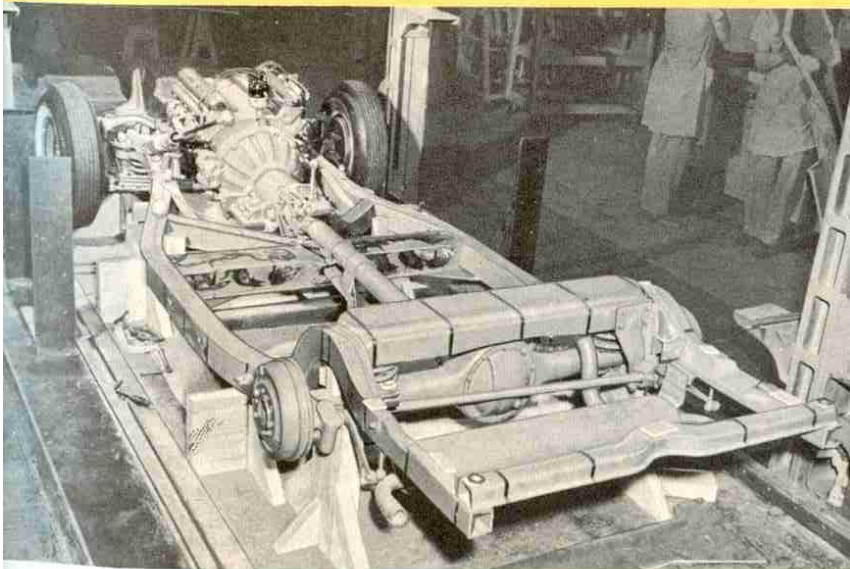

The chassis prior to assembly of structural members which, like the body shell, are Fibreglas.



(Above) installation of the door sill, one of the principal supporting members of the under body (right). (Above right) Fibreglas door frame is checked for fit.

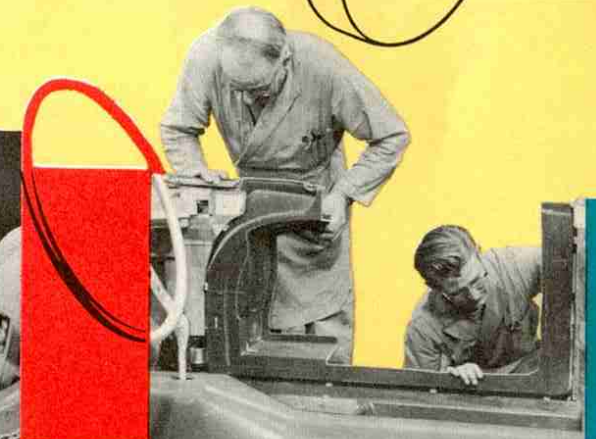

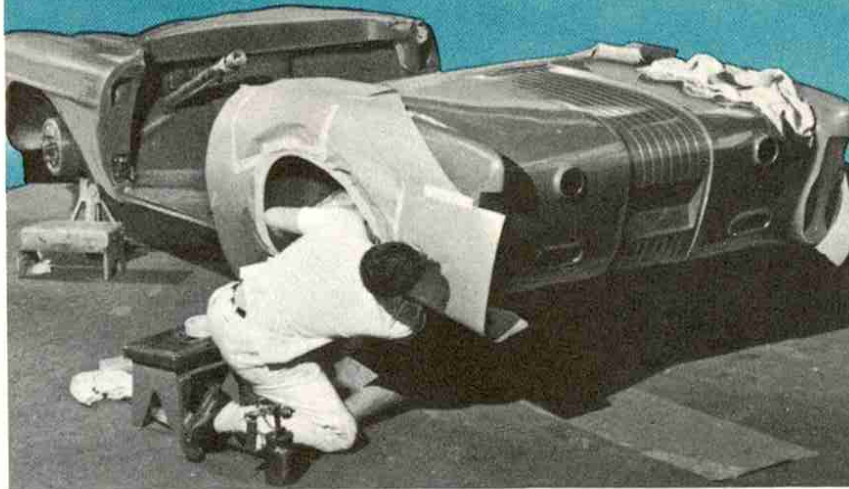

Up on blocks the partially assembled body (left) shows condition of Fiberglas before painting and brass metal before chrome plating. In the paint shop (above) a painter masks a fender in preparation for painting the underfender.

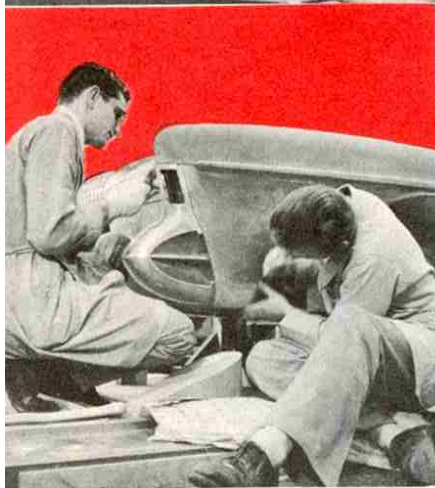
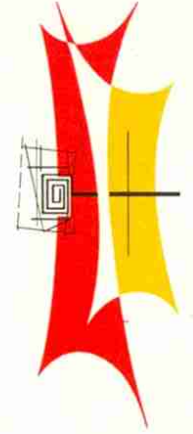

Metal workers install taillight assembly, filing away excess Fiberglas to insure a perfect fit.

Final Assembly and Installation of Trim



Floor covering is fitted to underbody prior to installation of seats.

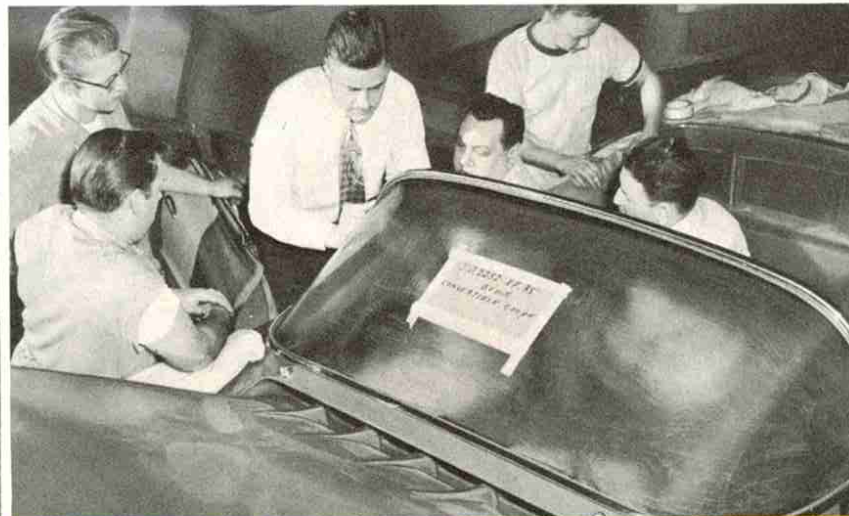

(Above) With the car almost completed, the plastic-coated windshield is fitted in place. Great care must be taken here to insure even pressure in the supporting molding. (At left) Chrome-plated bumper plate is positioned. Temporary white plastic covering protects other bumper parts.



Painter prepares to touch up damaged paint. Note rubber boot on wheel. It will protect tire against damage during shipment.

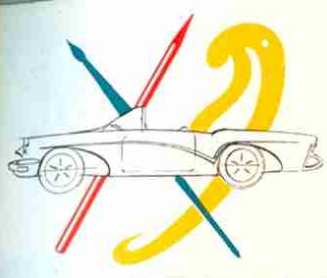

SKETCHING

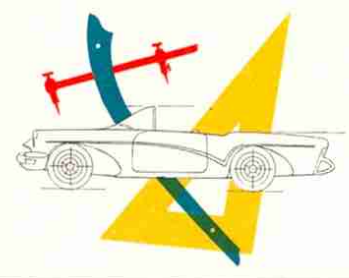

DRAFTING

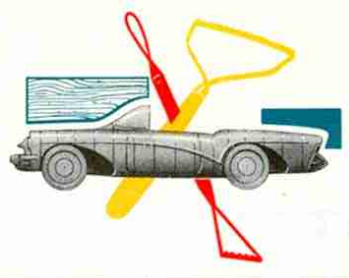

MODELING

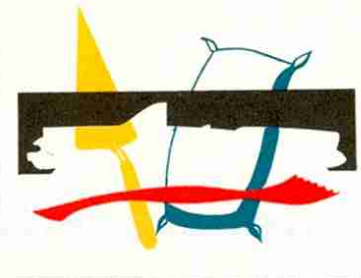

CASTING



FABRICATION

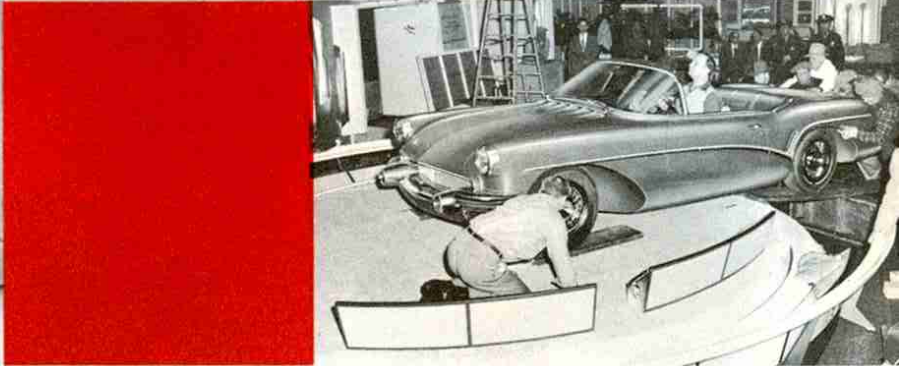
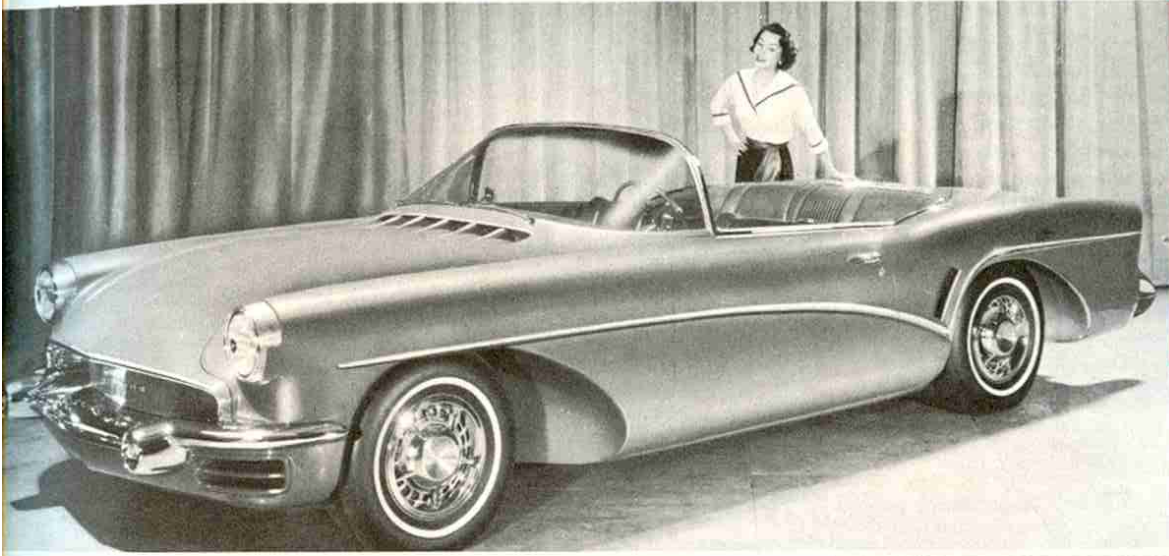

A few days later at a showroom several hundred miles away! The glittering, handmade product of many thousands of hours of work is pushed up on the turntable where it is soon the center of attraction to thousands of eager, admiring eyes. More than 2,000,000 people in New York, Miami, San Francisco, Los Angeles, and Boston saw this GM Motorama Dream Car.

Publicity and Public Showing

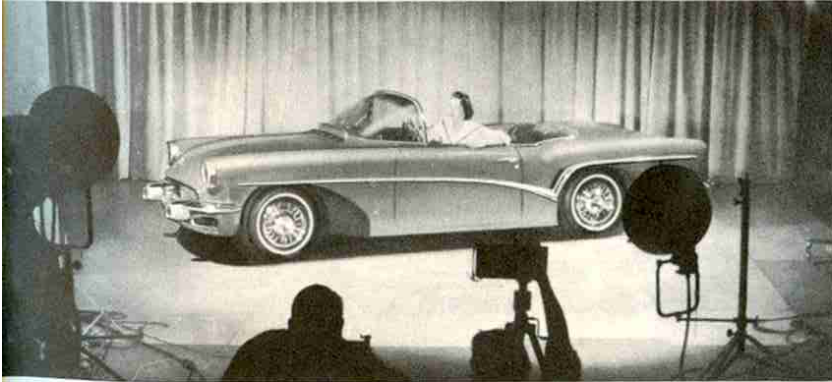

Almost before the paint is dry, the car is claimed by the high-fashion photographer who with a battery of "Strobe" lights and a lovely model prepares the publicity pictures that are sent to leading newspapers and agencies throughout the country.

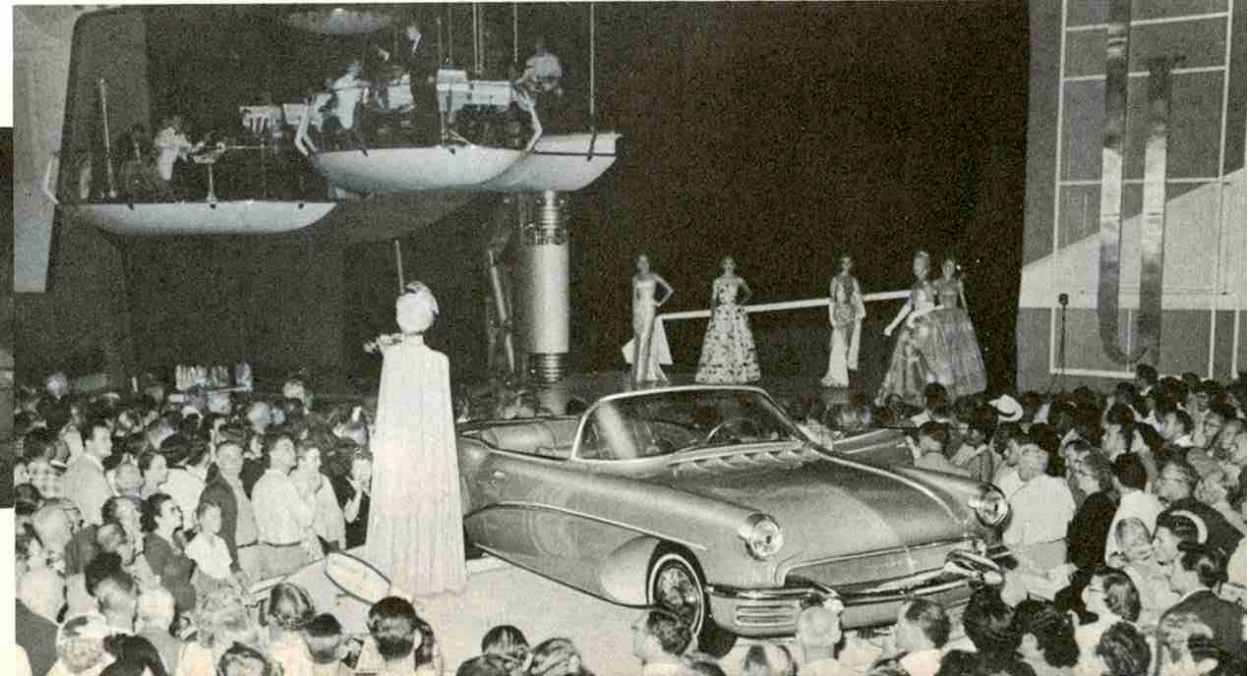

Three Case Histories Prove That

CASE HISTORY

1

Lightweight AEROTRAIN

From the first, railroad rolling stock has been designed primarily to handle freight in large quantities and great bulk. This requirement has produced our mighty freight cars and locomotives.

Passenger service, always a railroad problem from a profit standpoint, has also employed big, heavy equipment—the average passenger car is over 80 feet long and weighs 65 tons. The cost of hauling this tremendous weight can only be subdivided among the fares of the 80 people or less who ride in the coach. That explains in part why passenger service has been a losing proposition for most of the nation's railroads.

Reducing the total weight of the individual passenger car seemed to be the logical answer. A lighter car and hence a lower weight per passenger would mean improvement all down the line: lower equipment costs, lower operating costs and higher average speeds. How this was accomplished in the GM Aerotrain is told in the picture story at right.

Clay model, built to one-eighth scale, reveals the design proportions of the new engine in relation to the cars. An automotive "panoramic" windshield, a distinctive front end and a new location for the engineer's cab were features of the new design.

Maintaining the existing floor and seat level seemed desirable to assure passengers an adequate view of the passing

scene. Access to loading platforms and to the ground were also basic requirements which had to be observed in the new design.

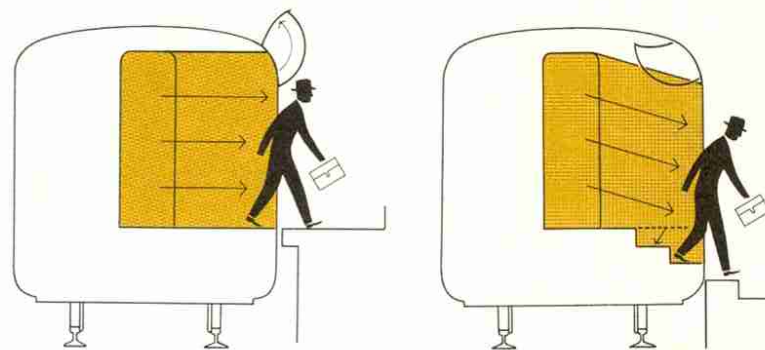

New engine employs only one 1200 h.p. Diesel electric propulsion unit instead of the conventional two units. Auxiliaries in front drive current-producing generators for lights and refrigeration. The reduction in horsepower and in weight make possible a big savings in fuel. Fully loaded the GM Aerotrain uses only 1.3 gallons of fuel per mile at top speed.

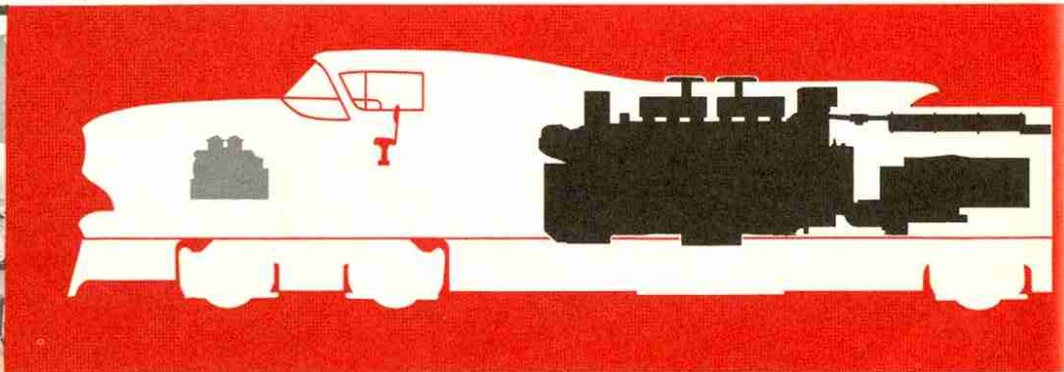
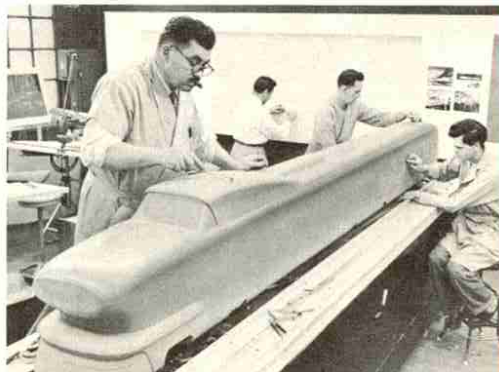

Styling Starts Under The Surface

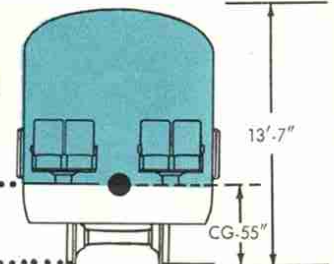
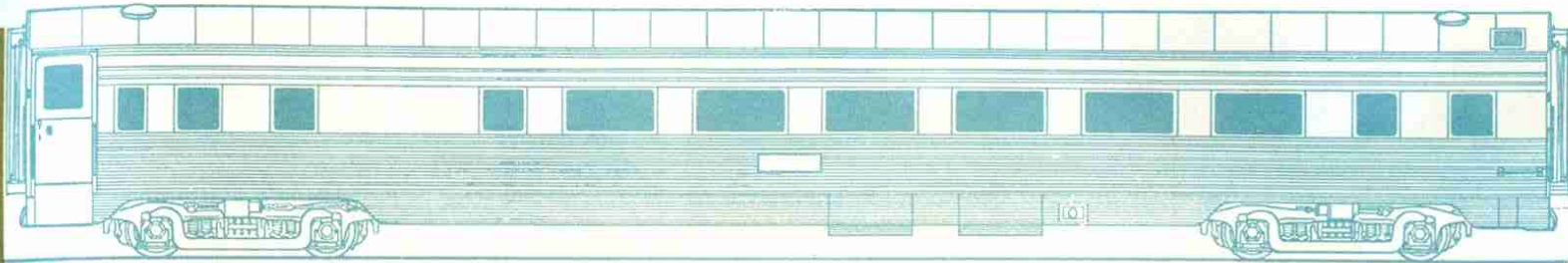

How to adhere to these limitations and yet accomplish another goal, that of lowering the center of gravity was a problem. Here's how all of the proposed requirements were accomplished. A drastic reduction in head room, heretofore somewhat too generous, would save on material and weight. The use of a lightweight aluminum body instead of steel would effect further savings in weight. Mounting this light body on a rugged steel underframe would lower the center of gravity as much as 10 inches.

Instead of cars 80 feet long, the designers of the Aerotrain recommended shorter cars, each 40 feet long. Overall car height was reduced from 13 feet 7 inches to 10 feet 9 inches. Construction of the new body with the exception of the underframe followed the lines of inter-city buses. The underframe more than exceeds the safety characteristics of conventional cars, offering great resistance to "squeeze" or impact.

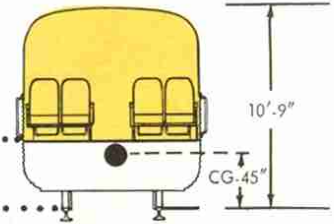
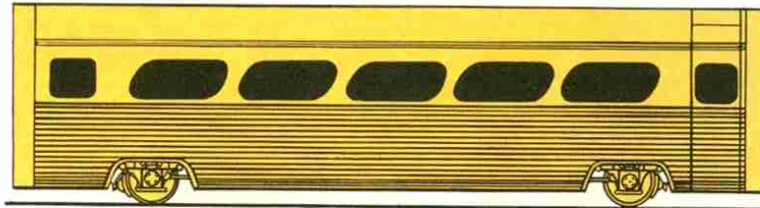

First presented to the public at the GM Powerama in Chicago the GM Aerotrain was a popular success. Railroad executives and the public alike were eager to try the new train under actual operating conditions.

Locating the baggage compartments under the seats after the manner of inter-city buses made efficient use of space. Other compartments on the same level house air conditioning equipment.

For platform stops, a roof panel opens up to give ample head room (below left). For ground level stops (below right) the car platform rotates and becomes a pair of steps.

Aerotrain interior resembles that of a bus with compartments at either end to house lavatories and cooking pantry.

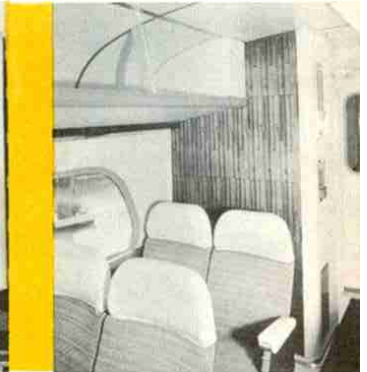
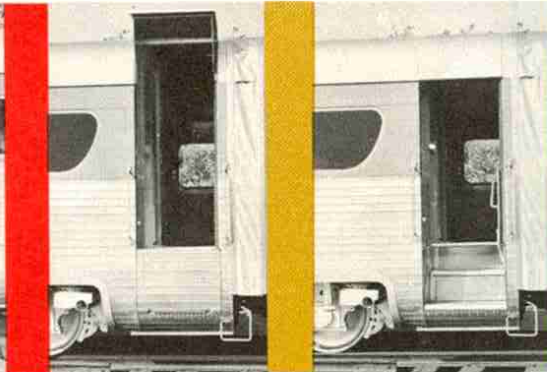
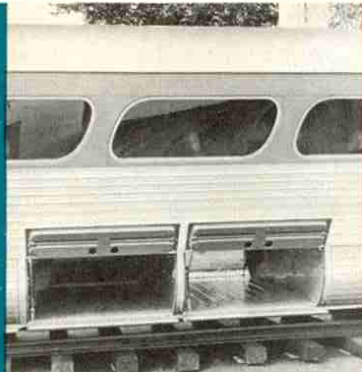

The final result: ten lightweight cars seating a total of 400 people and a new locomotive specially designed to do the job. Notice how the form of the locomotive is in keeping with

the coaches, which bear a resemblance to inter-city buses yet are right at home on the rails. The GM Aerotrain is a development of the Electro-Motive Division, General Motors.



2

L'UNIVERSELLE TRUCK

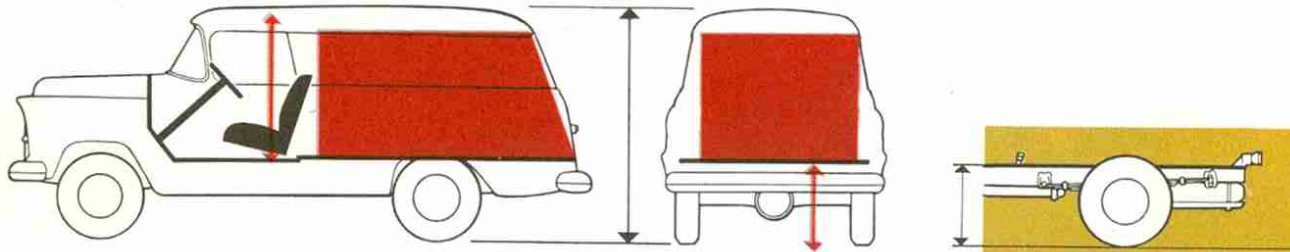

The silhouette of a standard 1/2 ton panel truck hadn't changed for a number of years. It was determined by the height of the conventional chassis frame, which was about 28 inches off the ground. Allowing for seat height and headroom for the driver put the overall height at more than 80 inches. Overall length was about 200 inches to provide the

desired capacity in the load compartment.

The designers of L'Universelle Truck set out to develop a new design concept for transporting a load. Their goal was to increase payload for the same size package, improve accessibility to all parts of the load, and improve visibility for the driver.

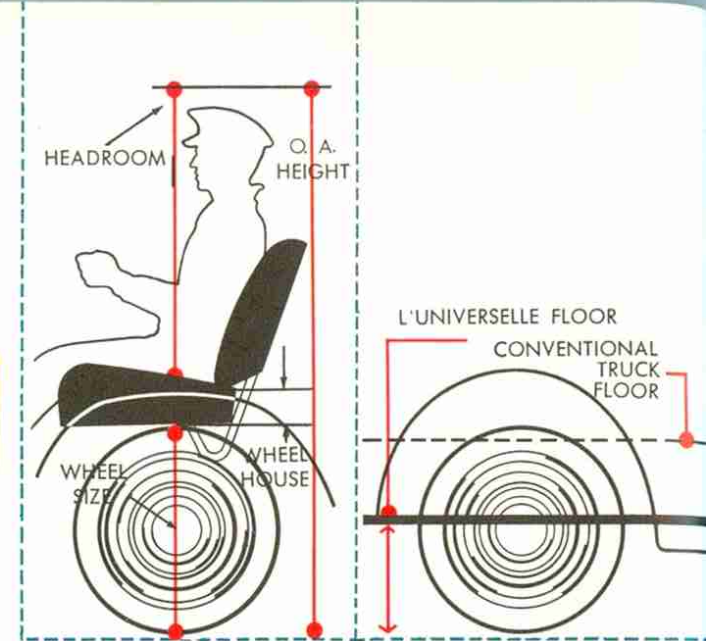

REARRANGEMENT OF COMPONENTS

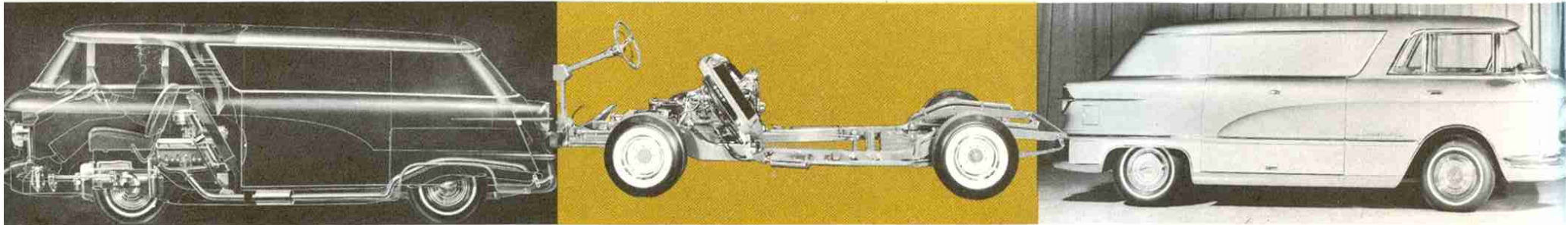
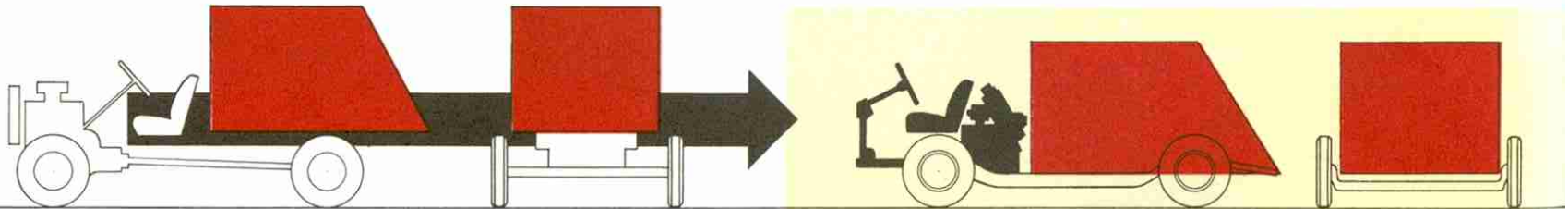

The basic limitation in the conventional arrangement is the presence of the propeller shaft which connects the engine in front with the axle in the rear. If the propeller shaft could be eliminated, new design possibilities would be opened up.

This concept called for a front wheel drive with the engine and transmission located behind the front axle. Then the driver's compartment could be moved forward and the load floor lowered with the help of a new drop axle in the rear. These fundamental chassis changes were the basis for the design of the L'Universelle.

Rearrangement of the basic components in the manner shown produced a longer and lower silhouette. Shaping the appearance of the new arrangement centered around giving form to a box, breaking it up with pleasing lines and contours.

The difference in new and old silhouette proportions is shown at right. The new design was shorter in overall length and lower in height, yet had a greater cubic capacity. Surrounded by glass, the driver had the same visibility as in a bus. Access to any part of the load was easy with 3 large doors—one on each side in addition to the one at the rear.

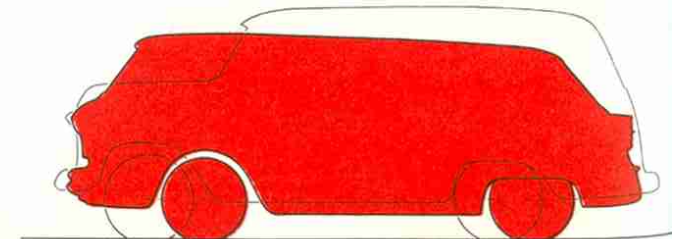

3 KITCHEN OF TOMORROW

One of the most fertile fields for fundamental design research is in the development of labor-saving appliances for homemakers, an activity in which the Stylist has been increasingly effective in recent years.

Shown on this and the following pages is a fascinating example of the wonderful results of this kind of effort: "A Kitchen of Tomorrow." Included in this remarkable dream room are dozens of ideas all designed to make the homemaker's job easier and more pleasant. All controls and work surfaces are conveniently located and almost every door and drawer is power operated.

In answer to the trend toward outdoor living and eating, the Kitchen of Tomorrow has a cooking and mixing center adjacent to, and accessible from, the patio. To accommodate the large-volume buying that is typical of suburban living, six individual refrigeration units, having a total of 35 cubic foot capacity, are provided.

And in keeping with the mounting responsibilities of the modern American mother, there is a Planning Center with special communication devices and a "magic" telephone.

In the interests of reduced footwork, the Kitchen is compact and well arranged, with two eating areas and a complete laundry located nearby.

As you examine its fascinating features, notice how the Stylist has combined well proportioned plane surfaces with rich textures and unusual colors. There's nothing complicated here;

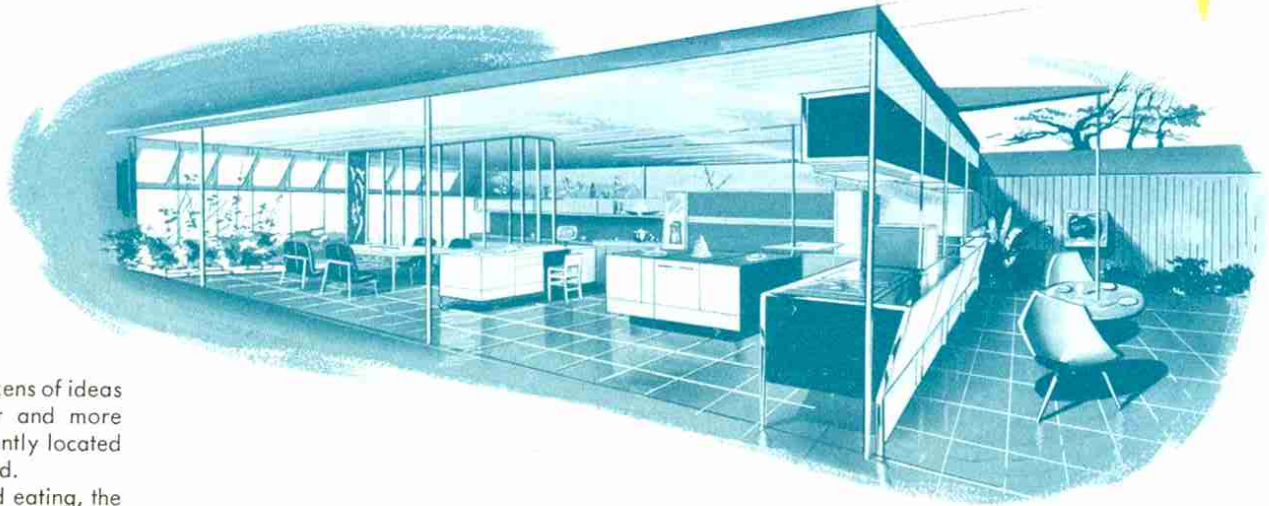

instead there's a functional simplicity plus a certain elegance of detail that are apparent in the close-ups on the following pages.

The Kitchen of Tomorrow is primarily an experiment in simplified everyday living, but in addition it was designed as a display. Notice that the near side is completely opened up so that throngs of people passing by can clearly see the interior.

An experiment, yes, but it's full of ideas that appeal to the homemaker. Those that are enthusiastically received will soon—sooner than you think—be available for your kitchen.

The Kitchen of Tomorrow is sponsored by Frigidaire Division, General Motors.

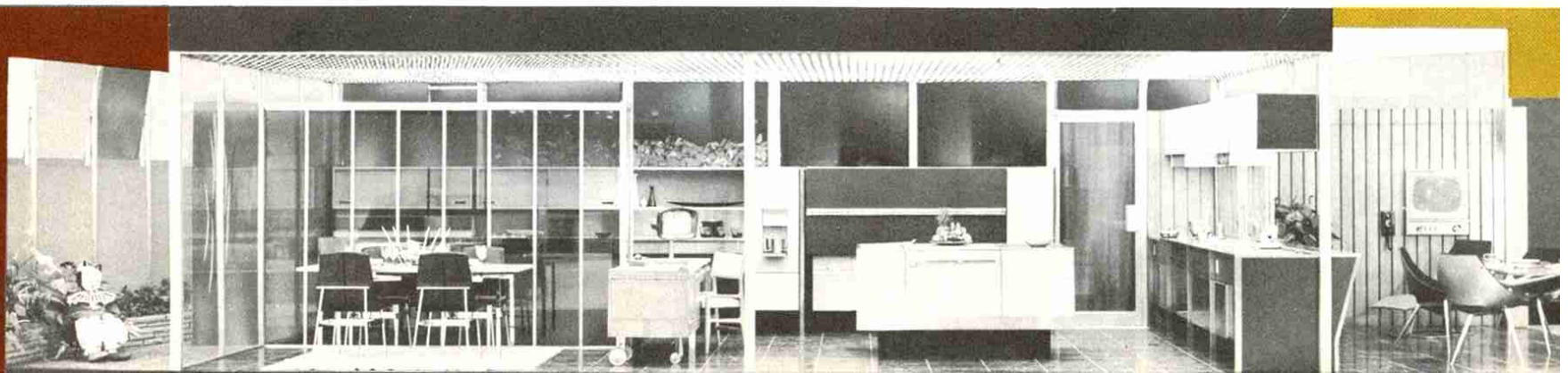

Functional Beauty in the Kitchen of Tomorrow

LAUNDRY CENTER: Conveniently located near the kitchen, the compact Laundry Center includes an ironer that opens like a spinet; doors on washer and dryer that are operated by foot pedals, leaving the hands free to handle clothes; and easy-to-reach cupboards which store laundry supplies.

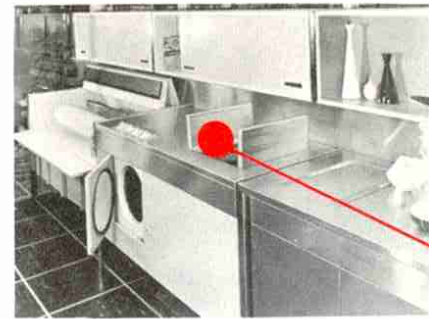

REFRIGERATION CENTER: Here are five individual refrigeration units in all, each designed to handle a specific cooling job. Their total capacity is about 35 cubic feet. The waist high beverage cooler provides ample room for bottled beverages, freeing space in the refrigerator for foods. Adjacent to the beverage cooler is the ice maker and water cooler which automatically provides crushed ice, ice cubes, or cooled drinking water at the touch of a button.

The main refrigeration unit has two horizontal units, both located conveniently at waist level. On top is the 10 cubic foot refrigerator and below is a freezing unit of the same size. Both doors operate individually in a vertical direction in response to a touch on the horizontal bars. Within, sliding trays and racks that pull out permit maximum use of space and eliminate "digging" into back corners. The hydrator, to right of the refrigeration unit, provides ample room for storage of fresh foods and dairy products at somewhat higher temperatures than are found in the other units. The entire unit rolls out like a filing cabinet drawer and the individual sliding drawers are accessible from either side.

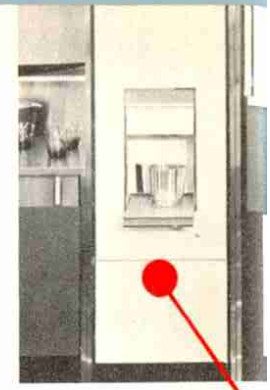

DINING CENTER: The sectionalized polaroid glass wall in the background hides the Laundry Center. If desired, it can be adjusted to allow penetration of light. Dining table, chairs and accessories are in keeping with a dining room which is essentially part of a kitchen.

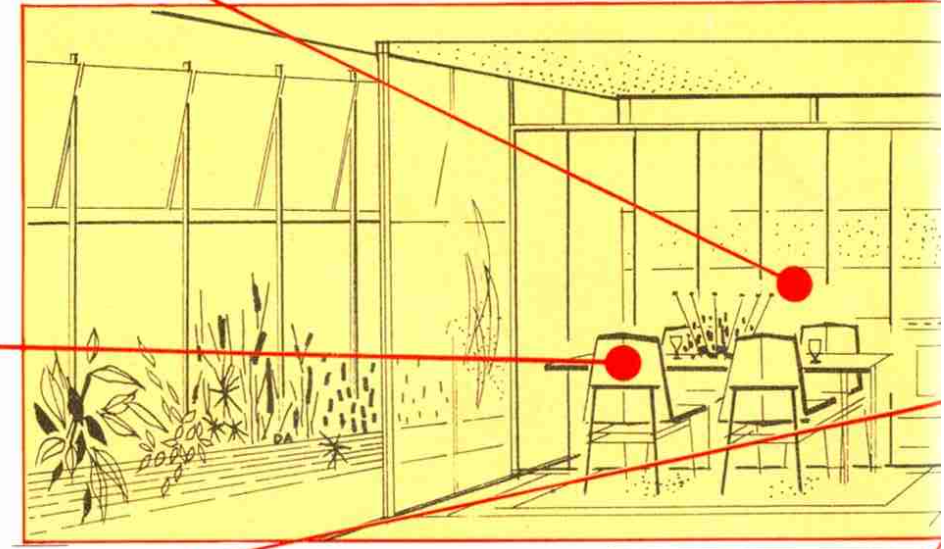
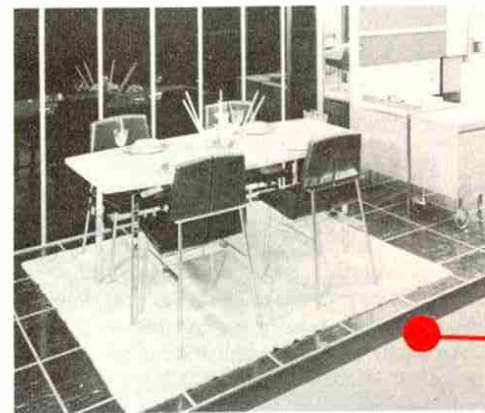

PLANNING CENTER: The "home manager's" office—a place to write, study, place orders, plan meals and file menus. Located here are several of the most modern communication devices yet designed for the homemaker. One is a step-saving, supervisory television viewer that can be focused on play areas, front door or baby's room. The second is a telephone which has several unusual features, including a p.a. system which permits phone conversations from anywhere in the room without going near the receiver, and a combination message-answering and recording device that takes over during the absence of the homemaker.

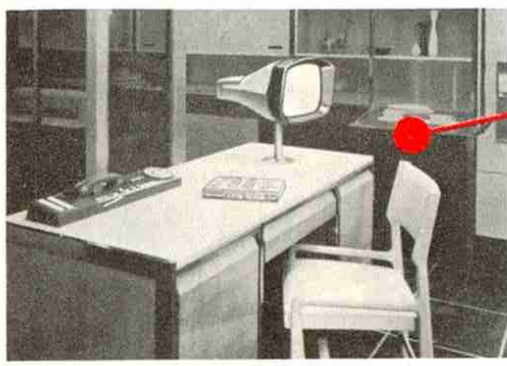

APPLIANCE CART: This compact power-driven appliance cart houses a toaster, waffle grill, hot plate, coffee maker, chafing dish, and ample serving surfaces. It can be moved anywhere in the house or patio and is ideal for serving away from the kitchen, providing hot toast or waffles or coffee without running to and from the kitchen. The built-in hot plate and chafing dish are equally helpful in keeping food dishes warm and appetizing.

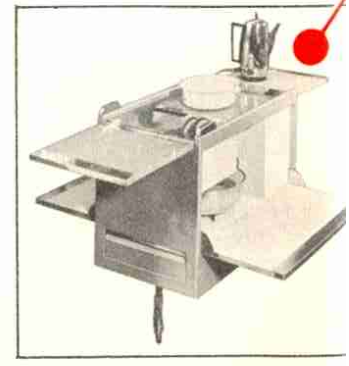

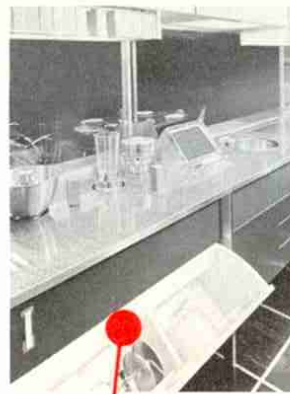
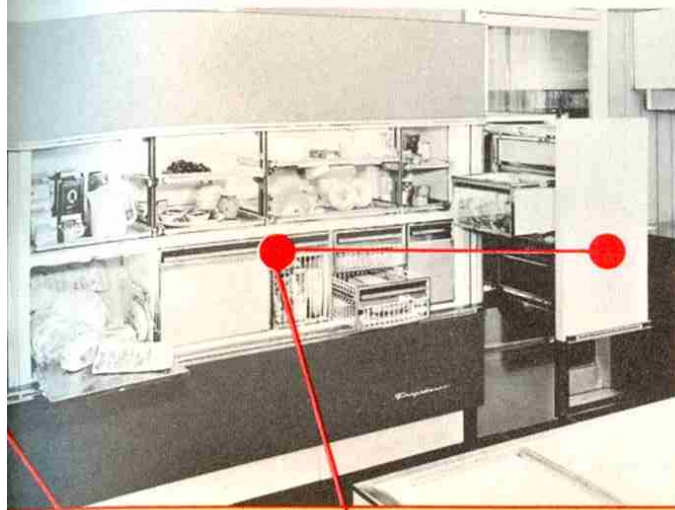

MIX CENTER: Emerging from the working surface of the Mix Center are two motor-driven universal shafts, to which motorless appliances such as mixer, blender, juice extractor, shredder, and potato peeler can be fitted. This idea not only has the advantage of convenience and ease of operation, but eliminates the need for individual motors on each appliance, a factor in economy. New projector-type recipe viewer rises out of its recess in the Mix Center at touch of button. Selector dialing brings any one of 200 recipes and full-color photos into focus. At right is a small semi-circular sink which showers vegetables with needle-like sprays of water, simplifying their cleaning and rinsing.



COOKING CENTER: Located on the wall between the kitchen and patio, the Cooking Center is equipped with sliding glass doors and dual controls which allow cooking control from either side—a meal started on the kitchen side can be completed and served from the patio side.

Cooking elements on the surface rotate at the touch of a button, unless something is resting on them. On the opposite side of one is a griddle; the other a flat work surface. The rotisserie oven rises out of the top of the cooking center hydraulically, again by push button. Glass doors on either end roll down automatically. In operation the oven is completely hidden from view.

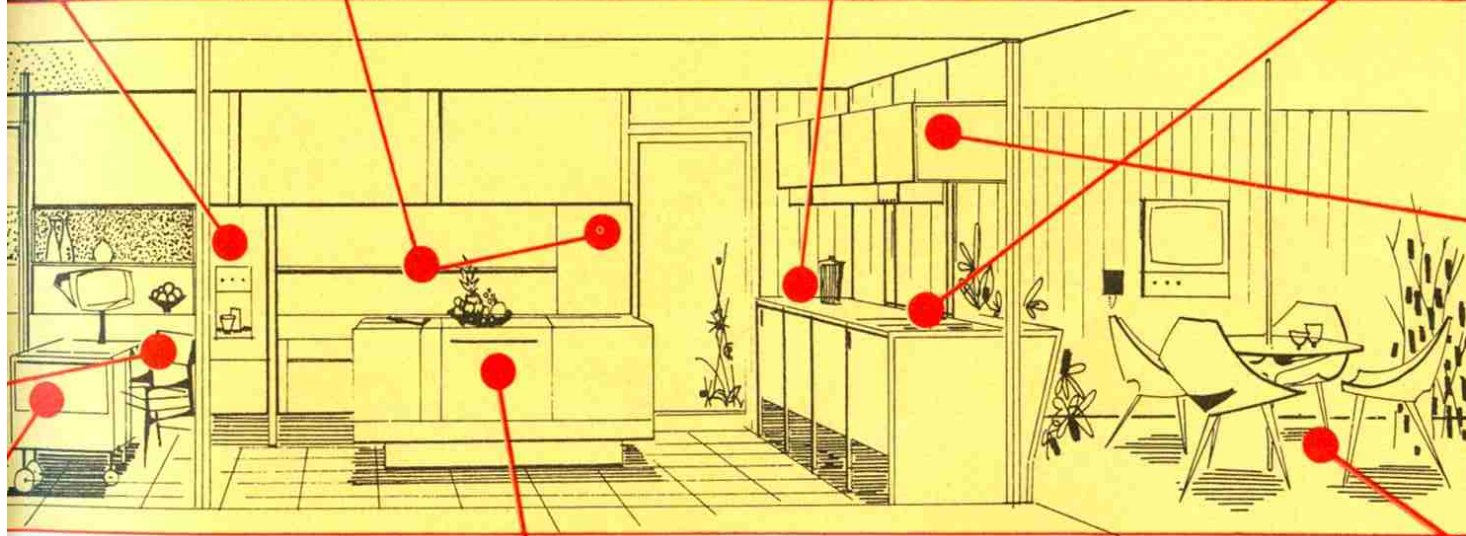

WALL CABINETS: No more reaching and straining on tiptoe with these cabinets. Push a button, and the shelves slowly drop from the bottom of the cabinet bringing their contents down within convenient reach. Panels at bottom of units house controls for oven, surface unit and cupboard.

SINK AND DISHWASHER ISLAND: Here in the center of the Kitchen of Tomorrow is an island which includes a double sink, food waste disposer, rotating shelves, automatic dishwasher, and power operated chopping block. The sink has a self-rinsing feature that prevents accumulation of deposits and keeps cleaning to a minimum. The new faucet has its controls conveniently located at the tip. One control regulates volume of flow and the other regulates temperature, eliminating the trial-and-error adjustment necessary with conventional valves.

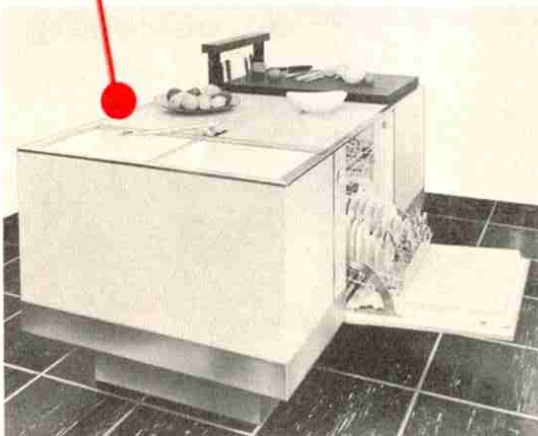

PATIO: Exterior view of Mix and Cooking Centers and Patio eating area. Legless table, outside television, modern chairs extend to the outside the contemporary feeling that prevails within. Note location of cooking controls which permit operation from the patio of surface cooking units, oven and cupboard shelves.



A page out of the Stylists' book — a full-sized drawing of a prototype car with color airbrushed in. The car is the Buick Wild Cat III, subject of the picture story beginning on page 48 of this booklet.

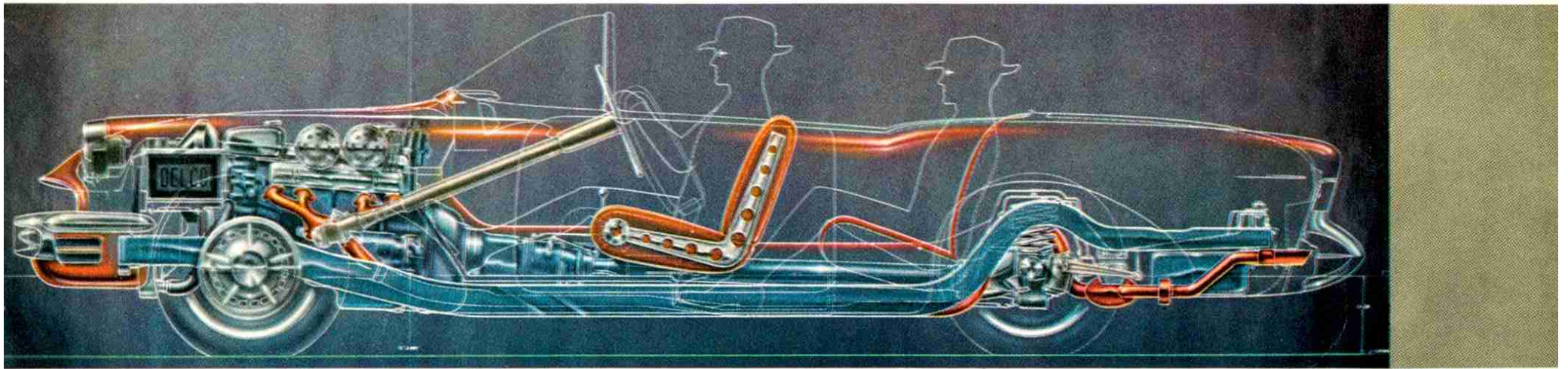

Styling

The Look of Things **TO COME**

Enormous progress has been made in the field of styling in the past thirty years. Much is being accomplished today. Nearly everything being manufactured or built bears the imprint of the modern Stylist.

But in styling as in most human endeavors, the big job lies ahead. The big opportunity is in the future. And what a thrilling future it is: the chance to design beauty into products not yet made; to shape machines not yet invented; to enrich the lives of people not yet born. That's the opportunity that awaits the talented young people who aspire to the styling profession.

So this is not the end of the styling story, it's really only

the beginning.

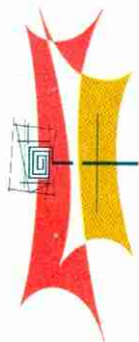

GM
GENERAL
MOTORS

● STYLING THE LOOK OF THINGS ●